

# Bedroom Floor Plan Symbols

## Complete Guide

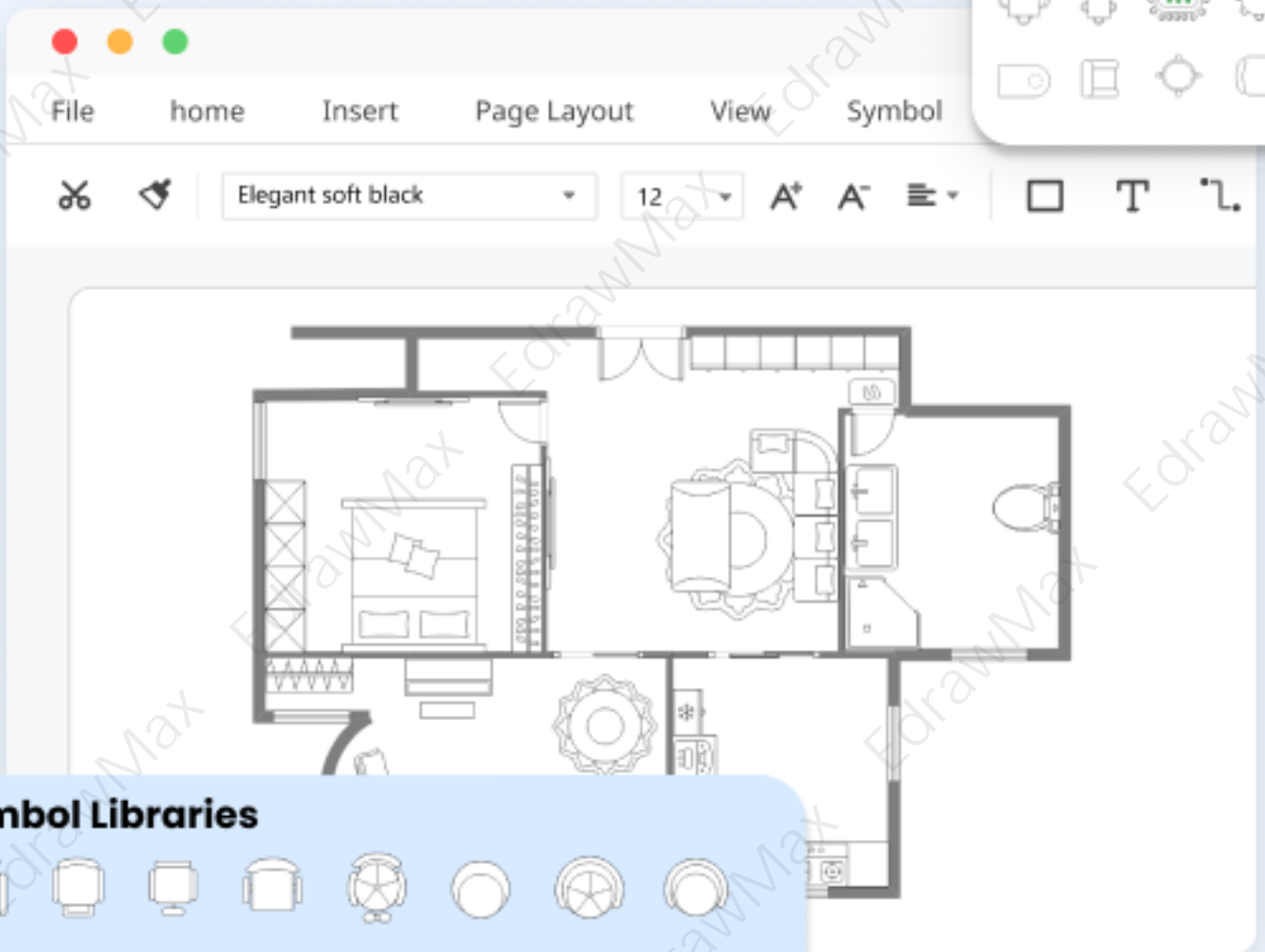

# Bedroom Floor Plan Symbols

## CONTENT

1. What Are the Bedroom Floor Plan Symbols .....	2
2. The Types of Bedroom Floor Plan Symbols .....	3
2.1 Bed Symbols .....	3
2.2 Wall Shell & Structure Symbols .....	5
2.3 Doors and Windows Symbols .....	6
2.4 Table & Chair Symbols .....	8
2.5 Sofa Symbols .....	12
2.6 Cabinet and Bookcases Symbols .....	15
2.7 Carpet Symbols .....	17
3. Where to Find Bedroom Floor Plan Symbols .....	18
4. How to Use Bedroom Floor Plan Symbols .....	19
4.1 How to Use Bedroom Floor Plan Symbols in EdrawMax .....	19
4.2 How to Create More Bedroom Floor Plan Symbols in EdrawMax .....	21
5. Free Home Plan Software .....	24
6. Final Thoughts .....	25
You May Also Like: .....	25

### Do You Want to Make Your Bedroom Floor Plan?

EdrawMax specializes in diagramming and visualizing. Learn from this article to know everything about bedroom floor plan symbols, and how to use bedroom floor plan symbols. Just try it free now!

**Download EdrawMax:** <https://www.edrawsoft.com/download-edrawmax.html>

A **bedroom floor plan**<sup>1</sup> is a technical 2d drawing that depicts the structure and physical features of a bedroom in a bird's eye view using specific symbols. We use **bedroom floor plan symbols** to represent the components and attributes of a bedroom in a floor plan.

Here, you will learn everything about **bedroom floor plan symbols**, including their types and uses. Learn how to find and use these symbols on EdrawMax Online. Also, learn how to create personalized symbols to make your floor plan.

<sup>1</sup> Bedroom floor plan: <https://www.edrawsoft.com/homeplan.html>

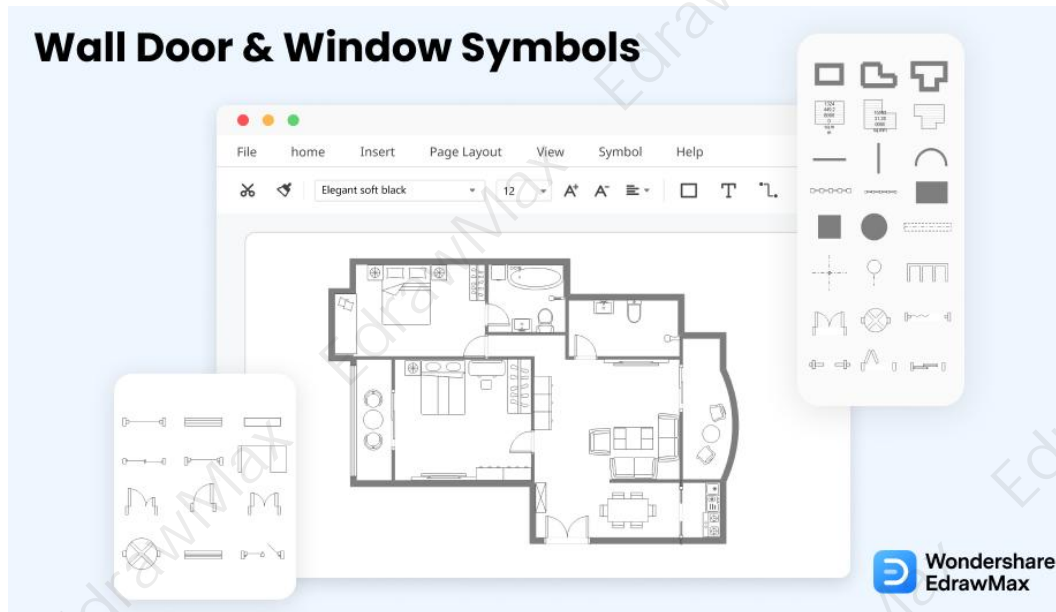

## 1. What Are the Bedroom Floor Plan Symbols

A bedroom floor plan visually represents the layout, furniture, appliances, windows, and electrical products in a bedroom. We use **bedroom floor plan symbols** to illustrate the furniture and structure of the bedroom from a bird's eye view. A bedroom floor plan is one of the schematic drawings in a home plan of a residential house. These make it easier for the owner to communicate with builders and designers.

Every bedroom must have three basic features, or it is just a random room in the house. A bedroom has a bed, windows for light and ventilation, and a closet. The **bedroom floor plan symbols** represent each of these features and other bedroom elements in a two-dimensional diagram. The purpose of making a bedroom floor plan is to specify the arrangement of furniture and the layout before construction.

The bedroom reflects the owner's personality and is mostly decorated in various adaptable designs. We use **bedroom floor plan symbols** to focus on the furniture configuration of the bedroom. The main thing to consider is the bedroom size because when you design a bedroom, you have to leave space to move freely. You can get bedroom floor plan symbols for EdrawMax and use them to create your drawing with a simple drag and drop.

### **Bedroom Floor Plan Symbols:**

Bedroom floor plan symbols illustrate the furniture and structure of the bedroom from a bird's eye view, which represent each of these features and other bedroom elements in a two-dimensional diagram.

## 2. The Types of Bedroom Floor Plan Symbols





Every bedroom must have three basic features, or it is just a random room in the house. A bedroom has a bed, windows for light and ventilation, and a closet. The **bedroom floor plan symbols** represent each of these features and other bedroom elements in a two-dimensional diagram. The purpose of making a bedroom floor plan is to specify the arrangement of furniture and the layout before construction.





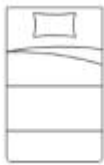
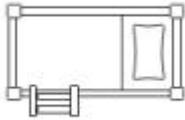

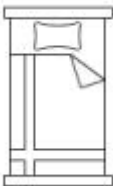
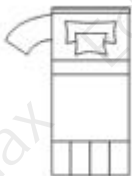



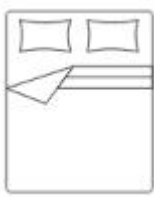
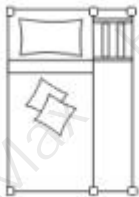
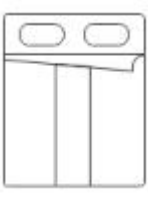

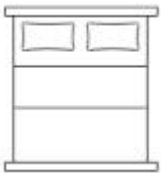

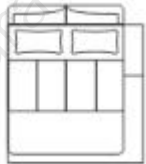
- Bed Symbols
- Wall Shell & Structure Symbols
- Doors and Windows Symbols
- Table and Chair Symbols
- Sofas Symbols
- Cabinets and Bookcases
- Carpet Symbols

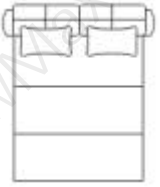
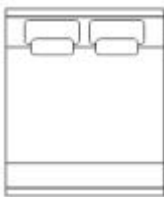
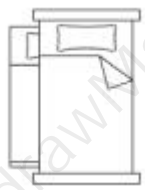
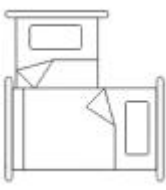
### 2.1 Bed Symbols

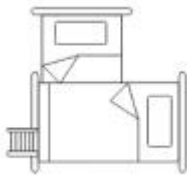
The layout and design of a bedroom depending on the size, type, and arrangement of the bed. You can place the bed next to a side wall to maximize free space or place it in the middle with side tables. Bed symbols are one of the key elements of a bedroom floor plan. These symbols include king beds, queen beds, bunk beds, and single beds. A bed is a symbol of security and privacy.

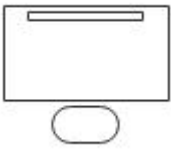
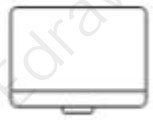
The owners customize the layout of most bedrooms, and they use home plan symbols to illustrate what they want to include. These symbols include bed symbols, windows and doors, furniture, sofas, wardrobes, etc. Bedrooms symbols represent the furniture, design, and appliances that the owner wants in the bedroom.

Single Bed 1	Single Bed 2	Single Bed 3
		
Single Bed 4	Single Bed 5	Single Bed 6
		















Single Bed 7	Single Bed 8	Double Bed 1
		
Double Bed 2	Double Bed 3	Double Bed 4
		
Double Bed 5	Double Bed 6	Double Bed 7
		
Double Bed 8	Single Trundle Bed	Bunk Bed
		
Bunk Bed 2	Crib	Bassinet
		
Vanity Table	Night Stand	Circular Bed
		
Circular Bed 2	Circular Bed 3	Circular Bed 4
		





Source: EdrawMax

## 2.2 Wall Shell & Structure Symbols

The purpose of using wall shell symbols is to outline the space where the owner could arrange the bed, closets, desk, chairs, and other furniture or appliances. These symbols are mainly used to depict the bedroom structure and specify the layout of each bedroom wall. These symbols create a 2D model that gives us an overview of the wall shell. Builders use these symbols to specify the size and design of the bedroom.

The most typical parts of a bedroom are walls. Exterior walls are represented by thicker lines, whereas internal walls are represented by thinner lines. There is sometimes no discernible difference between them. Instead of a single, solid line, outside walls can be represented by a black outline or double lines.

Wall	Vertical Wall	Curved Wall
		
Curtain Wall	Space	L-Space
		
T-Space	Room 1	Room 2
		
Room 3	Pilaster	Rectangular Column
		
Circular Column	Beam	Grid Origin
		

		
Grid Line		
		

Source: EdrawMax



### 2.3 Doors and Windows Symbols

















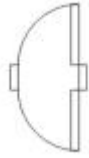

Doors and windows are essential in a bedroom floor plan. We use these symbols to illustrate the position of the window and door in the bedroom walls to create a healthy airflow in the bedroom and provide a comfortable environment. The goal is to add windows to leave a passage out for evacuation due to an emergency. There are various window and doors symbols based on their shape and size. These symbols include doors for closets, dressing rooms, and windows in different shapes and designs.

Doors resemble larger spaces between walls, with a curving line indicating which way the door will swing and providing clearance. Depending on their design and function, they may appear differently on floor plans.

The windows are portrayed as if they were part of the walls.

- Three parallel lines separate regular sliding-glass windows from solid walls.
- Casement windows have arcs that look like doors and demonstrate how they open outward.
- The bay windows are tilted like the edge of a stop sign, interrupting the wall's straight line trajectory.

Window	Open Window	Open Window 2
		
Open Window 3	Glider Window	Casement Window

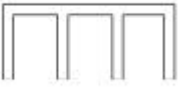
		
Bay Window	Double Casement Window	Opening
		
Door	Double Hung Door	Double Door
		
Uneven Door	Opposing Door	Revolving Door
		
Folding Door	Sliding Door	Double Sliding Door
		
By Pass Door	Bi Fold Door	Double Bi Fold Door
		
Sliding Glass Door	Overhead Door	Garden Window
		

















Source: EdrawMax



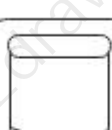







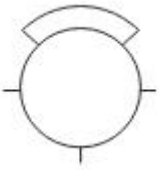

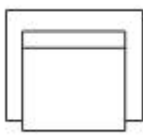

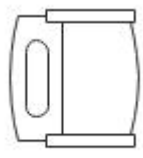
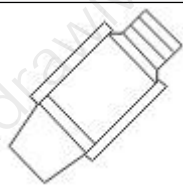
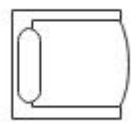

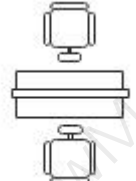
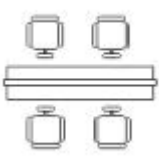
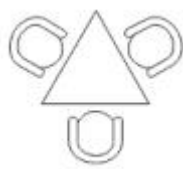
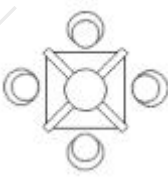
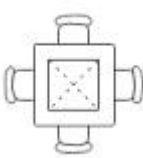

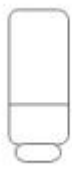





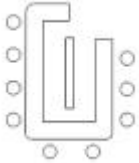

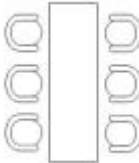

## 2.4 Table & Chair Symbols



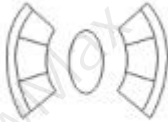

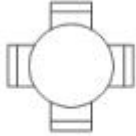
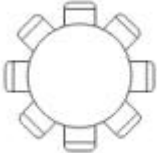
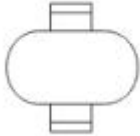
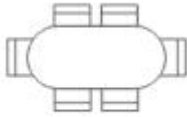

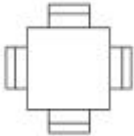
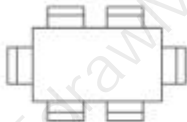
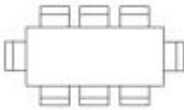
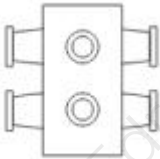











A table is one piece of furniture that falls right in place in any room you put them, while neatly placed sofas make furniture arrangement much easier. Table and chair symbols illustrate the position, shapes, and designs of various types of tables with chairs in the bedroom. These symbols include a study table, gaming table, desk, etc.

The table and chair are essential for any bedroom. You can use these **bedroom floor plan symbols** to illustrate the arrangement of chairs, tables, and desks for the family in your home. With each type of panel and equipment, you need a table to place the electrical products and chairs where your families will sit and work for the day.

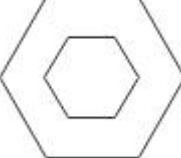
Chair 1 	Chair 2 	Chair 3 
Chair 4 	Chair 5 	Chair 6 
Chair 7 	Chair 8 	Chair 9 
Chair 10 	Chair 11 	Chair 12 
Chair 13 	Chair 14 	Chair 15 
Chair 16 	Chair 17 	Chair 18 

		
Chair 19	Chair 20	Recliner
		
Sling Chair	Lounge Chair	Table with Chairs
		
Style Station 1	Style Station 2	Style Station 3
		
Style Station 4	Style Station 5	Style Station 6
		
Style Station 7	Longue Chair 1	Longue Chair 2
		
Longue Chair 3	Longue Chair 4	Longue Chair 5
		
Bar Counter 1	Bar Counter 2	Bar Counter 3

		
Bar Counter 4	Bar Counter 5	Bar Counter 6
		
The Chair & Table 1	The Chair & Table 2	Sofa & Sofa Table 1
		
Sofa & Sofa Table 2	Dining Table 1	Dining Table 2
		
Dining Table 3	Dining Table 4	Dining Table 5
		
Dining Table 6	Dining Table 7	Dining Table 8
		
Dining Table 9	Dining Table 10	Circle Table & Chair 1
		
Circle Table & Chair 2	Circle Table & Chair 3	Circle Table & Chair 4

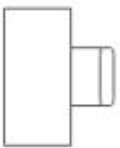
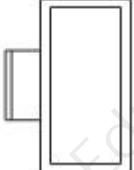
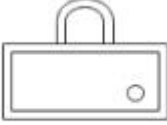
		
Cicle Table & Chair 5	Cicle Table & Chair 6	Cicle Table & Chair 7
		
Cicle Table	Oval Table	Conference Table 1
		
Conference Table 2	Conference Table 3	Rectangle Table
		
Diamond Table 1	Diamond Table 2	Corner Table
		
Semicircle Table	Fan Table	Ping Pong Table
		
Desk Table 1	Desk Table 2	Desk Table 3
		
Desk Table 4	Dressing Table	

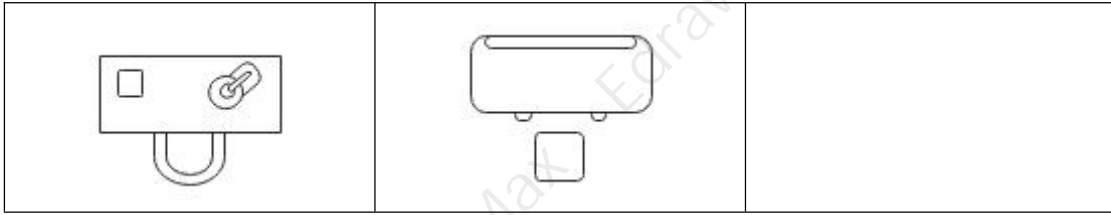











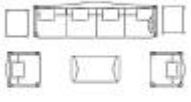
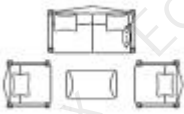
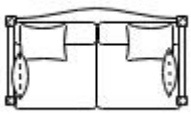

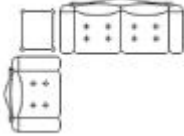
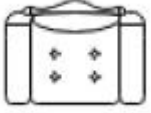
Source: EdrawMax

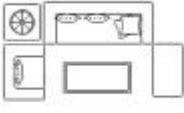
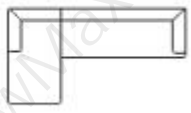
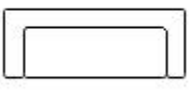
## 2.5 Sofa Symbols

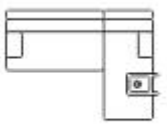
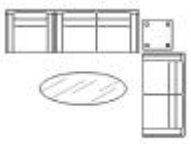
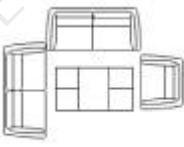
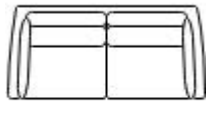

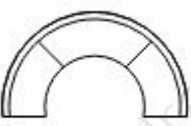

Perfect placement of sofas inside the bedroom makes furniture arrangement much easier because you can neatly position other furniture and appliances with their reference. Sofas symbols depict the arrangement of sofas and chairs so that people can sit together and easily converse.

Avoid arranging seating sofa near windows and make sure you are using the correct symbol based on the shape of your bedroom. There are various types of seating sofas in seating chart icons, including round sofas, couches, L-shape couches, and couches with a single seat. You can position sofas next to the corners and walls, or you can position round sofas in the middle, depending on the size of your room. Here are some seating sofa icons.

Sofa 1	Sofa 2	Sofa 3
Sofa 4	Sofa 5	Sofa 6
Sofa 7	Sofa 8	Sofa 9
Sofa 10	Sofa 11	Sofa 12

		
Sofa 13	Sofa 14	Sofa 15
		
Sofa 16	Sofa 17	Sofa 18
		
Sofa 19	Sofa 20	Sofa 21
		
Sofa 22	Sofa 23	Sofa 24
		
Sofa 25	Sofa 26	Sofa 27
		
Sofa 28	Sofa 29	Sofa 30
		
Sofa 31	Sofa 32	Sofa 33

Sofa 34	Sofa 35	Sofa 36
Sofa 37	Sofa 38	Sofa 39
Tea Table 1	Tea Table 2	Tea Table 3
Tea Table 4	Tea Table 5	Tea Table 6
Tea Table 7	Tea Table 8	Tea Table 9
Tea Table 10	Tea Table 11	Tea Table 12
Sofa Table 1	Sofa Table 2	Sofa Table 3







		
Sofa Table 4	Sofa Table 5	
		

Source: EdrawMax

## 2.6 Cabinet and Bookcases Symbols

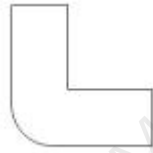
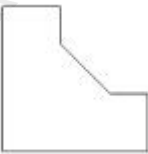
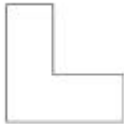

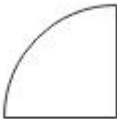







The cabinets and bookcases symbols specify the position of cabinets in any room of the house. These symbols include shelves, wood and glass cabinets, small and large bookcases. The most common spot for bookcases inside the bedroom is against one of the side walls behind a desk and a chair. Before going to sleep, people who like reading place bookcases inside their bedroom instead of living rooms or studying for convenience.

The **cabinets and bookcases symbols** specify the position of cabinets in any room of the house. These symbols include shelves, wood and glass cabinets, small and large bookcases. The most common spot for bookcases is inside the living room against the walls behind sofas or chairs.

Work Surface 	Corner Surface 	Corner Surface 2 
Corner Surface 3 	Corner Surface 4 	Island 
Corner Counter 	Platter Counter 	Bevel Counter 

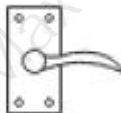

Bent Counter	Work Peninsula	Base
Base 2	Base 3	Base 4
Base 5	Base 6	Drawer
Drawer 2	Drawer 3	Drawer 4
Cabinet	Cabinet 2	Cabinet 3
Cabinet 4	Peninsula End-Shelf	Base Peninsula
Base Peninsula 2	Wall End-Shelf	Wall Corner
Wall Angle Cabinet	Track End-Bevel	Track 45 Deg



		
Track Corner	Tray Track	Locker
		
Handle	Handle 2	Handle 3
		
Handle 4	Handle 5	
		



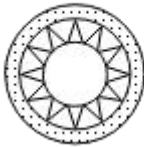

Source: EdrawMax

## 2.7 Carpet Symbols

You can use **carpet symbols** to specify the position of decorative carpets and mats inside the bedroom. You need to cover the whole floor with a carpet for a children's bedroom to keep your kids safe from falling and hurting themselves. These symbols include round, runner, rectangular, oval, and decorative carpets in various sizes. Most people place carpets next to their beds in the bedroom.

Different carpet designs for home floor plan. Choose a carpet for your sitting room, bedroom or children's room.

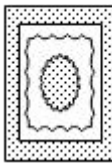
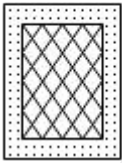
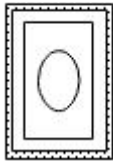
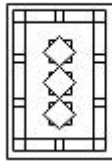
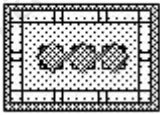
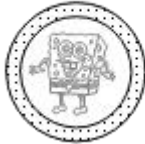
Carpet 1	Carpet 2	Carpet 3
		
Carpet 4	Carpet 5	Carpet 6

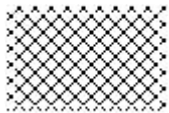
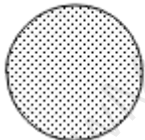
		
Carpet 7	Carpet 8	Carpet 9
		
Carpet 10	Carpet 11	Carpet 12
		
Carpet 13	Carpet 14	
		

Source: EdrawMax

### 3. Where to Find Bedroom Floor Plan Symbols

You can save time by creating an accurate bedroom floor plan with details and clearly representing each component using pre-drawn **bedroom floor plan symbols**.

You can easily find bedroom floor plan symbols in the symbol library of [EdrawMax<sup>2</sup>](https://www.edrawsoft.com/edraw-max/).

EdrawMax gives you more than 26000 symbols that you can use to create a bedroom floor plan or any other diagram. You can go and search for the symbols you want in EdrawMax and click on the bedroom floor plan. Go to the home plan category and use a simple drag and drop to add any symbol you want.

#### EdrawMax Bedroom Floor Plan Symbols:

EdrawMax is the best resources for bedroom floor plan symbols, you can find hundreds of bedroom floor plan symbols here. Just drag and drop, you can create bedroom floor plan easily.

<sup>2</sup> EdrawMax: <https://www.edrawsoft.com/edraw-max/>

## 4. How to Use Bedroom Floor Plan Symbols

Follow these instructions to learn how to use bedroom floor plan symbols and easily create more bedroom floor plan symbols with EdrawMax.

### 4.1 How to Use Bedroom Floor Plan Symbols in EdrawMax

Instead of wasting time drawing the bedroom floor plan symbols or icons on paper, you should look for a way to design a bedroom floor plan easily. **EdrawMax** is well equipped to design a bedroom floor plan.

#### Step 1: Login EdrawMax

If you are new here, you should use your Email to register EdrawMax, but if you're already the EdrawMax's user, you just need to login EdrawMax for free. Open EdrawMax select "**Engineering**", and find "**Building Plan**", and click "**Home Plan**", then open a new canvas or just open a built-in template.

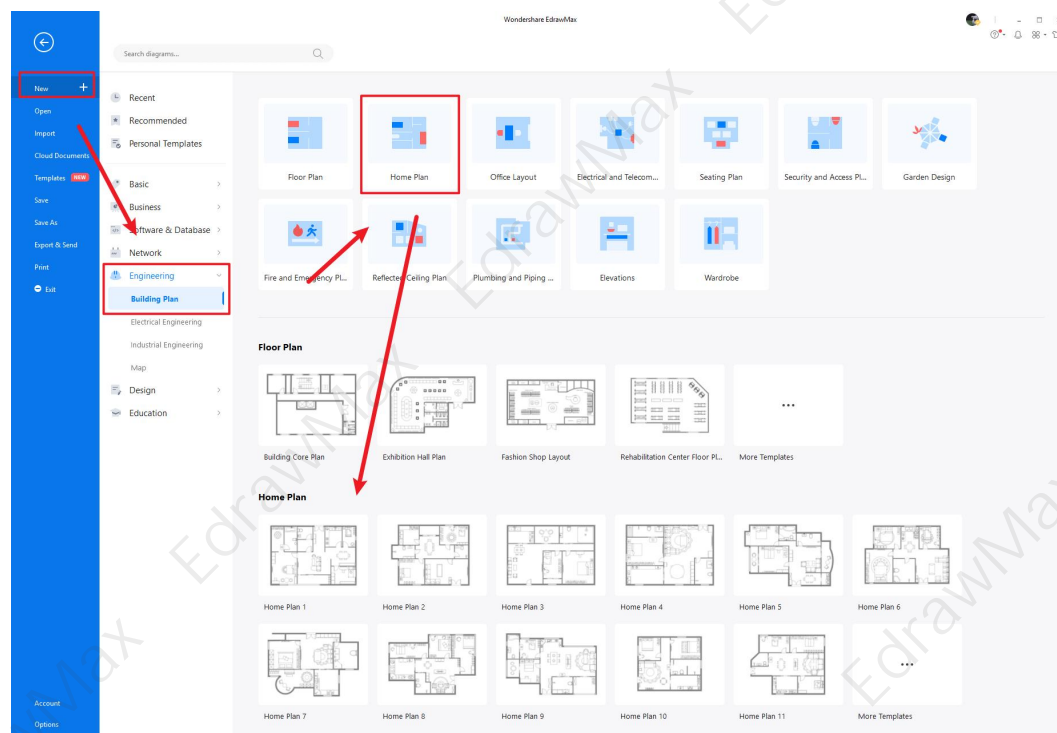

#### Step 2: Select Office Layout Symbols

Unlike physical drawing, EdrawMax helps to create a bedroom floor plan easily. In the symbol section of EdrawMax, you will find over 260,000 vector-based symbols that you can use in your designs. In EdrawMax, you can find bedroom floor plan symbols in **Symbol Libraries** on the left toolbar. You can click on the "+" option to open a new canvas to make your bedroom floor plan. On the left side of the canvas, you will see a symbol library with many bedroom floor plan symbols. You can search for specific symbols in the search bar.

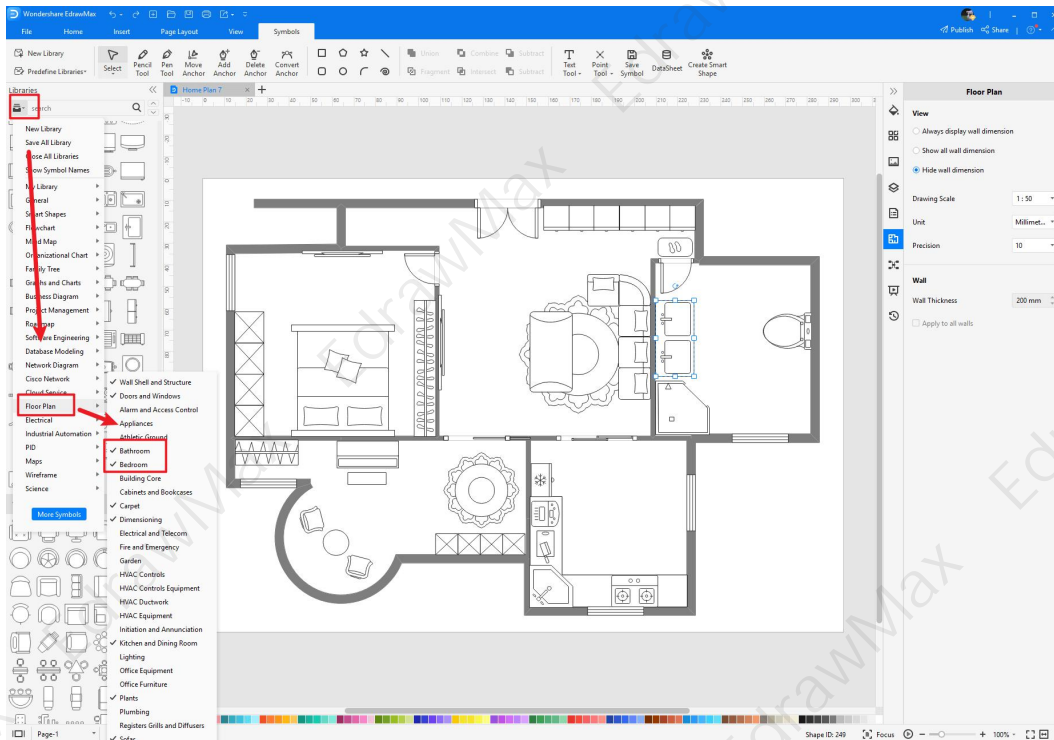

### Step 3: Drag and Drop

Once you find the proper bedroom floor plan symbols you want, just drag and drop the symbols to the canvas easily. Keep customizing by choosing the right symbols, proper scale or dimensions, and adding more details, like color, font, and etc. When completed your bedroom floor plan, you can export your file or share your design effortlessly. Learn more [bedroom floor plan guide](#)<sup>3</sup> here if necessary.

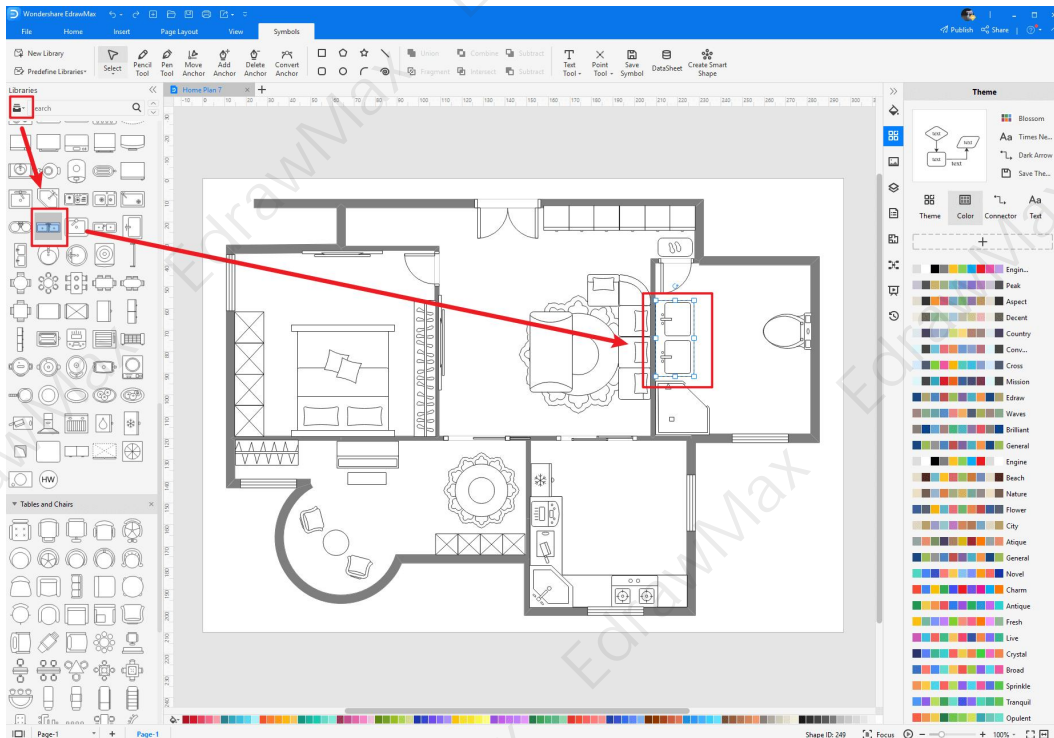

<sup>3</sup> Bedroom floor plan guide: <https://www.edrawsoft.com/floorplan/design-your-own-house-floor-plans.html>

## 4.2 How to Create More Bedroom Floor Plan Symbols in EdrawMax

EdrawMax provides you with thousands of symbols to create your diagram. Sometimes you want to use unique or personalized symbols in your diagram that are not in the library. EdrawMax gives you a simple solution to this problem. Follow these steps when you don't find the bedroom floor plan symbols you want or you wish to create your symbols to make your diagram.

### Step 1: Find Symbol Tool

If you can't find any symbol similar to the one you want, you can use the pencil tool, pen tool, and anchor tool to draw your personalized bedroom floor plan symbols. It is much easier to draw the symbol you want on EdrawMax instead of searching for the one that suits your requirements. You can also save your symbol in the library for later use.

- Select "**Symbols**" on the upper Toolbar;
- Use "**Pencil Tool**", "**Pen Tool**", "**Anchor Tool**" to create garden symbol from very beginning;
- Choose "**Union**", "**Combine**", "**Subtract**", "**Fragment**", "**Intersect**", "**Smart Shape**" to make your symbols.

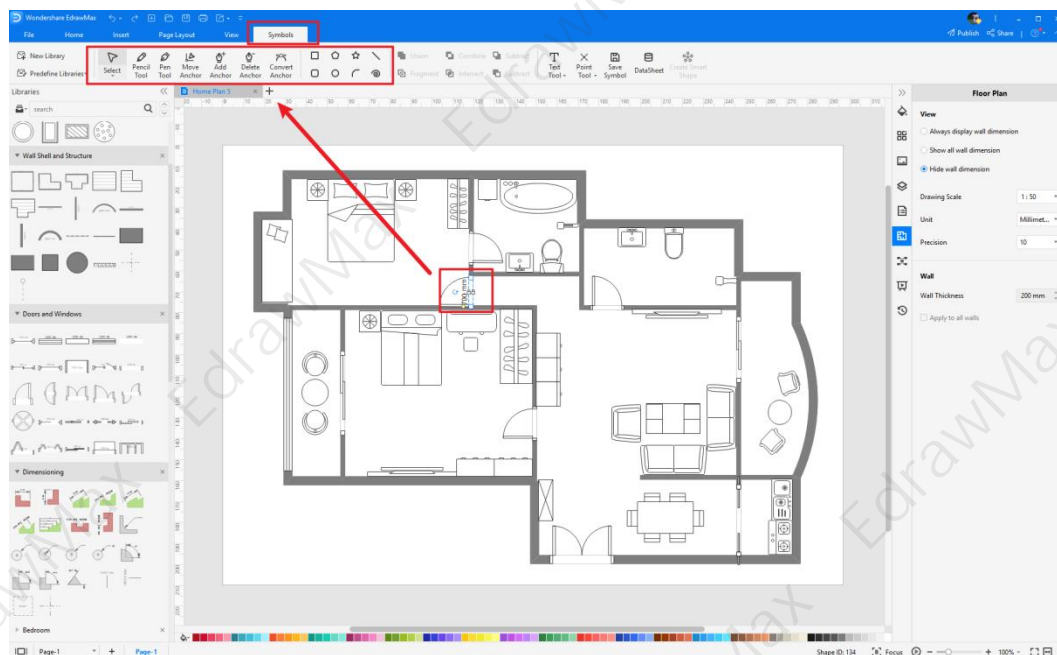

### Step2: Create Wall Door and Window Symbols

When you create a bedroom floor plan icon, make sure that the size, design, and other attributes of your icon go along with other bedroom floor plan icons. Follow these steps to draw perfect icons.



- Draw a rectangle at the angle.
- Add two tall posts with circles on top.
- Draw the two short legs on the other end.
- Add lines for headboard and mattress.
- Draw a blanket shape around the mattress
- Erase gray lines and add a pillow

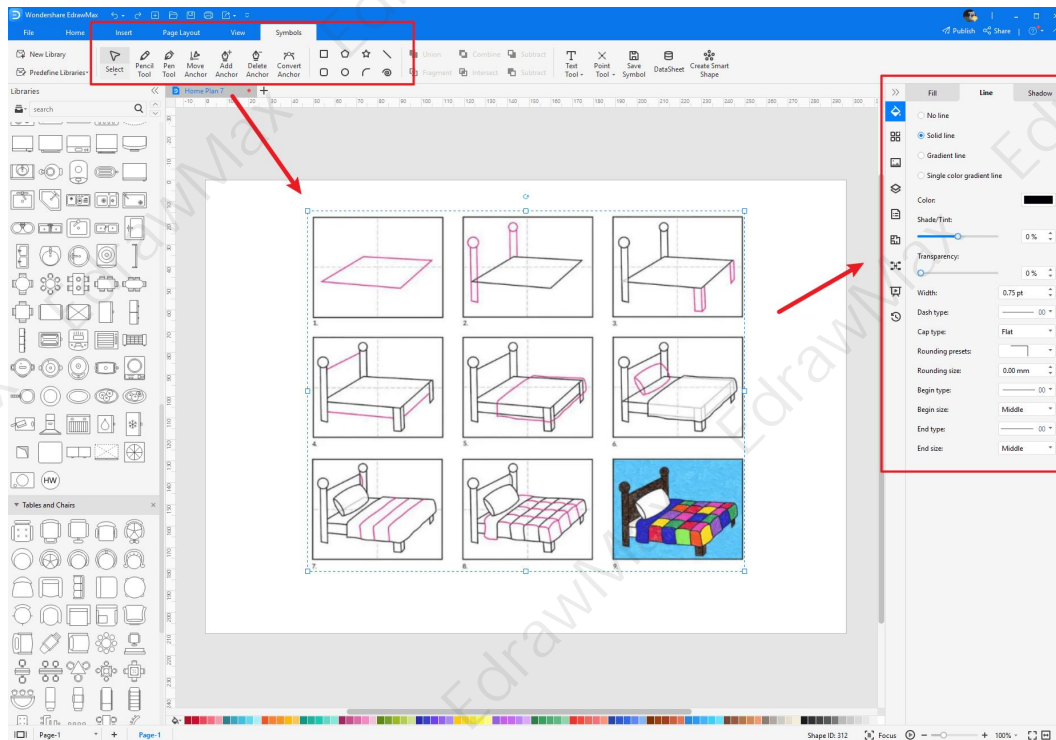

### Step3: Import Wall Door & Window Symbols

Except for creating new bedroom floor plan symbols in EdrawMax, you can import bedroom floor plan symbols from your end. Find "Insert" on the top navigate toolbar, and import images to turn into symbols. Or click the third option of the right toolbar to insert images faster.

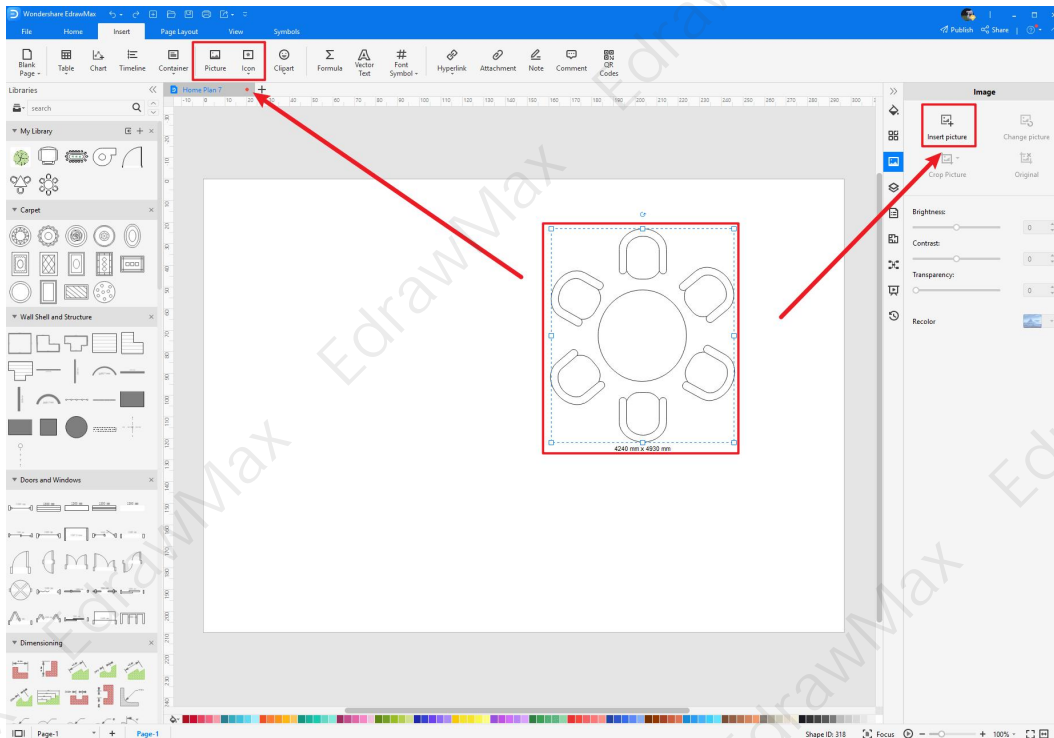

#### Step4: Save to Your Symbol Libraries

Once you completed your bedroom floor plan symbols design or import your symbol images, you should still click "**Symbols**" on top, and choose "**Save Symbol**" to your symbol Libraries. Or you can click "+" in My Library on the left toolbar. Learn more about how to draw a bedroom floor plan or design a bedroom from this [bedroom plan guide](#) here.

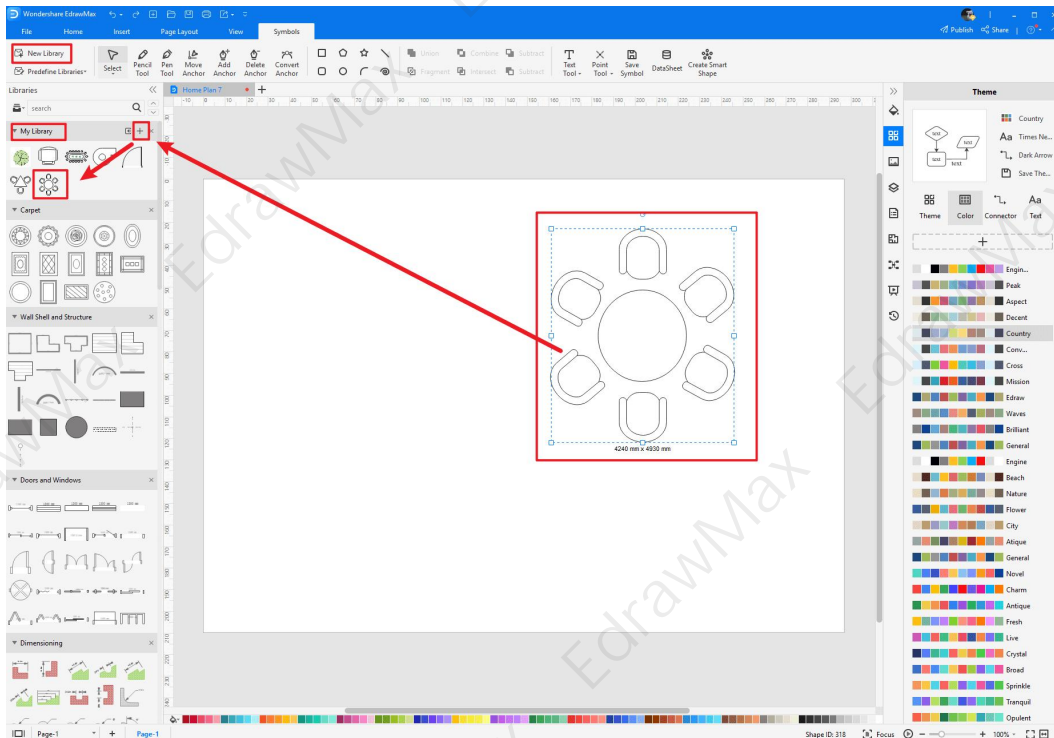









## 5. Free Home Plan Software

Instead of drawing it from scratch, it is much easier to create a bedroom floor plan with **free bedroom design software**<sup>4</sup>, such as EdrawMax. With EdrawMax, you get a comprehensive symbol library with thousands of bedroom floor plan symbols that you can use to make your diagram. It also gives you free editable templates that you can customize in a few minutes and complete your floor plan. EdrawMax Online is an excellent tool for team collaboration, and its easy-to-use interface makes it the first choice for everyone.

### key Features of EdrawMax:

- EdrawMax comes with free **bedroom floor plan examples & templates**<sup>5</sup> that are 100 percent customizable;
- The built-in vector symbols let you easily add bedroom floor plan components to your design;
- You can easily share the bedroom floor plan with your team and see the live revisions made by your team;
- EdrawMax lets you export the file in multiple formats, including MS Docs, PPTX, JPEG, PNG, PDF, and more;
- EdrawMax has a strong community of 25 million users who update the template community with their creative projects;
- EdrawMax is considered the best tool for beginners and professionals because of the user-friendly dashboard and easy drag-and-drop feature.

 	 
<ul style="list-style-type: none"> <li>✓ Create over 280 types of diagrams</li> <li>✓ Windows, Mac, Linux (runs in all environments)</li> <li>✓ Professional inbuilt resources and templates</li> <li>✓ On-premises software for business</li> <li>✓ Enterprise-level data security</li> </ul>	<ul style="list-style-type: none"> <li>✓ Create over 280 types of diagrams online</li> <li>✓ Access diagrams anywhere, anytime</li> <li>✓ Templates Community</li> <li>✓ Team management and collaboration</li> <li>✓ Personal Cloud and Dropbox Integration</li> </ul>
	

<sup>4</sup> Free bedroom design software: <https://www.edrawsoft.com/house-design-software.html>

<sup>5</sup> Bedroom floor plan examples & templates: <https://www.edrawsoft.com/home-plan-template.html>

## 6. Final Thoughts

The **bedroom floor plan symbols** make it easier for users to design a personalized layout of their bedroom by depicting each element and piece of furniture using pre-drawn icons. With a proper bedroom floor plan, the owner can easily explain the layout of their bedroom to the contractor.

When creating a bedroom floor plan, start with drawing walls and making a shell. Use bed symbols to position the bed and add architectural features. **EdrawMax** is the best free bedroom floor plan maker that gives you free symbols and templates to make your diagram. Its fast drawings and easy-to-use interface make it the first choice for amateurs and professionals.

### You May Also Like:

- <sup>6</sup>Bathroom Floor Plan Symbols
- <sup>7</sup>Kitchen Floor Plan Symbol
- <sup>8</sup>Home Plan Symbol
- <sup>9</sup>Electrical and Telecom Plan Symbols
- <sup>10</sup>Table & Chair Symbols

---

<sup>6</sup> Bathroom Floor Plan Symbols: <https://www.edrawsoft.com/symbols/bathroom-vector-icons.html>

<sup>7</sup> Kitchen Floor Plan Symbol: <https://www.edrawsoft.com/symbols/kitchen.html>

<sup>8</sup> Home Plan Symbol: <https://www.edrawsoft.com/home-plan-symbols.html>

<sup>9</sup> Electrical and Telecom Plan Symbols: <https://www.edrawsoft.com/electrical-telecom-symbols.html>

<sup>10</sup> Table & Chair Symbols: <https://www.edrawsoft.com/walldoor.html>



# Wondershare EdrawMax

Visualize, Innovate, And Collaborate With  
EdrawMax



[www.edrawsoft.com](http://www.edrawsoft.com)



[support@edrawsoft.com](mailto:support@edrawsoft.com)



[www.facebook.com/edrawsoft](http://www.facebook.com/edrawsoft)



[www.linkedin.com/company/edrawsoft](http://www.linkedin.com/company/edrawsoft)



[www.twitter.com/edrawsoft](http://www.twitter.com/edrawsoft)



[www.youtube.com/c/cutedrawedwin/videos](http://www.youtube.com/c/cutedrawedwin/videos)



[www.pinterest.com/edrawsoft/\\_created](http://www.pinterest.com/edrawsoft/_created)



[www.instagram.com/wondershare\\_edrawsoft](http://www.instagram.com/wondershare_edrawsoft)

---