

Floor Plan Symbols

Complete Guide

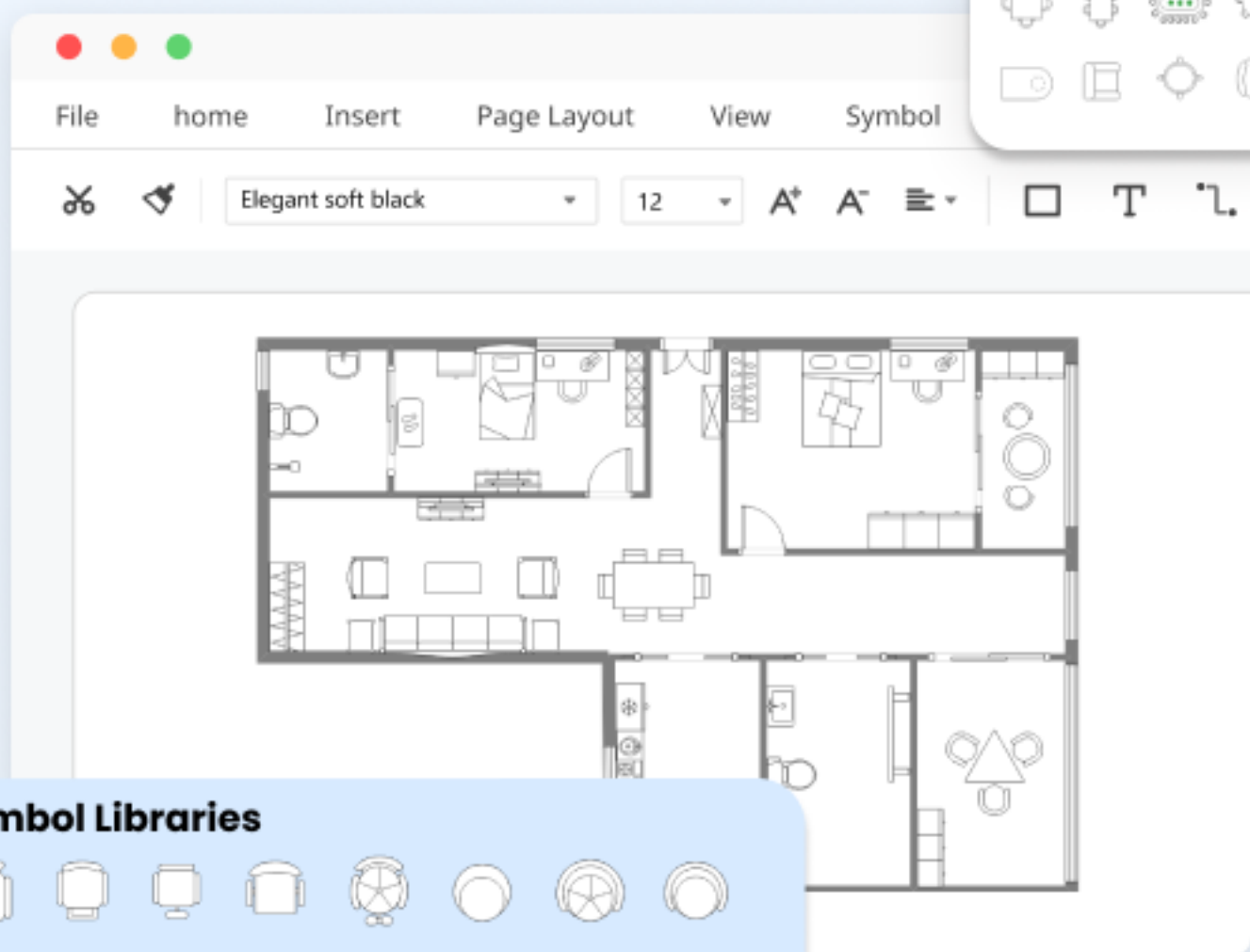

Symbol Libraries



Floor Plan Symbol

CONTENT

1. What Are the Floor Plan Symbols	2
2. The Types of Floor Plan Symbols	3
2.1 Wall Shell and Structure Symbols	4
2.2 Doors and Windows Symbols	5
2.3 Appliance Symbols	6
2.4 Athletic Ground Symbols	8
2.5 Bathroom Symbols	8
2.6 Bedroom Symbols	11
2.7 Building Core Symbols	14
2.8 Cabinet and Bookcases Symbols	16
2.9 Carpet Symbols	19
2.10 Dimensioning Symbols	19
2.11 Fire and Emergency Symbols	21
2.12 Garden Symbols	25
2.13 HVAC Symbols	33
2.14 Kitchen and Dining Room Symbols	40
2.15 Office Symbols	45
2.16 Plumbing and Piping Symbols	50
2.17 Reflected Ceiling Plan Symbols	58
2.18 Seating Chart Symbols	64
2.19 Security Plan Symbols	71
2.20 Elevation Symbols	74
3. Where to Find Floor Plan Symbols	82
4. How to Use Floor Plan Symbols	82
4.1 How to Use Floor Plan Symbols in EdrawMax	82
4.2 How to Create More Floor Plan Symbols in EdrawMax	84
5. Free Floor Plan Creator	87
6. Final Thoughts	88
You May Also Like:	88

Do You Want to Make Your Floor Plan?

EdrawMax specializes in diagramming and visualizing. Learn from this article to know everything about floor plan symbols, and how to use or create floor plan symbols. Just try it free now!

Download EdrawMax: <https://www.edrawsoft.com/download-edrawmax.html>

Any civil engineer needs to draft a **floor plan**¹ first to implement the construction process. A Floor Plan shows the view of a building interior from above. It demonstrates the structure of a house's map, rooms, space, and arrangements of other elements used for building construction. This plan illustrates the layout of a home or a building. A floor plan is embodied with **floor plan symbols**.

The placement of elements is done professionally, and all the symbols are used according to the requirements and needs of an architect. These symbols cover all the elements used to complete a floor map. It includes symbols of doors, windows, walls, plumbing, stairs, electricity connections, appliances, interior design, cabinets, bookshelves, tubs, and stoves. In this article, you can learn everything about **floor plan symbols**.

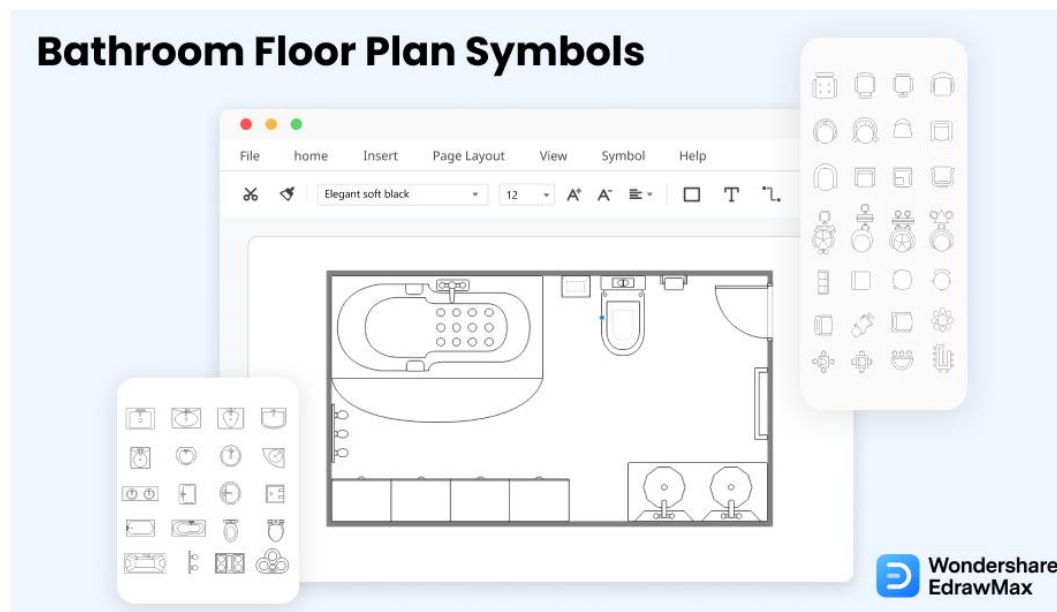

1. What Are the Floor Plan Symbols

A floor plan gives a clear and detailed view of a building or property to give the buyer and construction team an idea about construction and design details. **Floor plan symbols** denote all the construction elements in a floor plan. Designing a floor plan has become easy and

¹ Floor plan: <https://www.edrawsoft.com/what-is-floor-plan.html>

convenient because of EdrawMax. It enables many architects to map floor plans via existing layouts and provides thousands of symbols to add to a floor plan.

The **floor plan** is a scale diagram of a building and its division into rooms and sections viewed from above. It is used to plan and arrange the furnishings into a required space using suitable floor plan symbols. A floor plan is made for every story and section of a building to visually represent how a door opens and where all the passages go.

Floor Plan Symbols:

Floor plan symbols denote all the construction elements in a floor plan. Designing a floor plan has become easy and convenient because of floor plan symbols.















2. The Types of Floor Plan Symbols

Floor plan is used to plan and arrange the furnishings into a required space using suitable Floor Plan Symbols. In a plan, dimensions are drawn and mentioned between walls to elaborate room size and wall lengths on a floor. It helps prepare construction sites, interior arrangements, estimate budget, and create a building schedule. It represents your working spaces, location, and setup of a bedroom, hallways, kitchen, living room, bedrooms, garden, basement, and garage.

- Wall Shell and Structure Symbols
- Doors and Windows Symbols
- Appliance Symbols
- Athletic Ground Symbols
- Bathroom Symbols
- Bedroom Symbols
- Building Core Symbols
- Cabinet and Bookcases Symbols
- Carpet Symbols
- Dimensioning Symbols
- Fire and Emergency Symbols
- Garden Symbols
- HVAC Symbols
- Kitchen and Dinning Room Symbols
- Office Symbols
- Plumbing & Piping Symbols
- Reflected Ceiling Plan Symbols
- Seating Chart Symbols
- Security Plan Symbols
- Elevation Symbols

2.1 Wall Shell and Structure Symbols

Wall is the most common and basic and basic element of a building; it is built to protect an area or space. It is used to divide the construction building to form rooms and sections. Walls vary by size, style, and design. There are three types of walls; Building Walls, Exterior Boundary Walls, and Retaining Walls. Learn more details from [wall shell symbols²](#) guide here.

Wall	Vertical Wall	Curved Wall
		
Curtain Wall	Space	L-Space
		
T-Space	Room 1	Room 2
		
Room 3	Pilaster	Rectangular Column
		
Circular Column	Beam	Grid Origin
		
Grid Line		

² Wall shell symbols: <https://www.edrawsoft.com/walldoor.html>













		
---	--	--

Source: EdrawMax







2.2 Doors and Windows Symbols

A door is a passageway or transition from one place to another. It is a hinged, sliding, revolving barrier to enter or exit the room, building, hall, vehicle, or cupboard framework. There are different types of doors available for variety: hinged door, Dutch door, Pocket door, and French door.

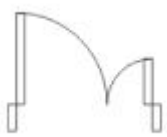
A window is an opening in a wall or roof made for the admission of air and light. These are often arranged for decoration purposes. There are numerous types of windows: fixed window, sliding window, single hung window, double-hung window, bow window, and casement windows. Learn more details about [door & window symbols](#)³ guide here.

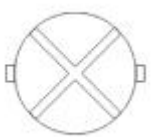
Window	Open Window	Open Window 2
		
Open Window 3	Glider Window	Casement Window
		
Bay Window	Double Casement Window	Opening
		
Door	Double Hung Door	Double Door
		

³ Door & window symbols: <https://www.edrawsoft.com/walldoor.html>







Uneven Door	Opposing Door	Revolving Door
		
Folding Door	Sliding Door	Double Sliding Door
		
By Pass Door		
		



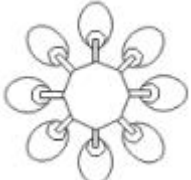

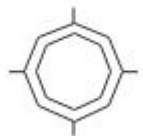





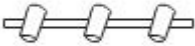



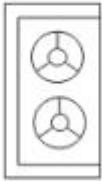
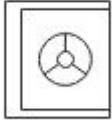

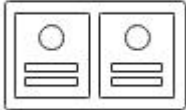

Source: EdrawMax

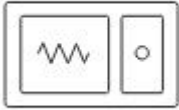
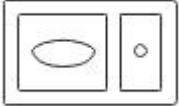
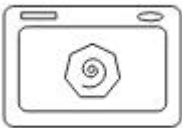

2.3 Appliance Symbols

Appliances are devices or equipment manufactured and designed to perform any particular task. These appliances run on electricity or gas, and a floor plan shows all the appliances used in a building section or room. These appliances are manufactured for households and offices generally.

- Household appliance
- Workplace appliance

Pendant Lamp	LED	Floor Lamp
		
Wall Lamp	Spotlight	Tube Light
		
LED Downlight	Shower Lamp	Fan

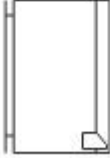
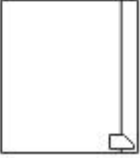
		
Air Exhaust Fan	Gas Stove 1	Gas Stove 2
		
Refrg 1	Refrg 2	Chest Freezer
		
Cooker	Range	Microwave
		
Dishwasher	Washing Machine	Water Cooler
		
Oven	Tumble Dryer	Coffee Maker
		
Disinfection Cabinet	Flat-Panel TV	Keyboard
		
Video Game	Food Cooler	Vending Machine

		
Water Heater		
		

Source: EdrawMax

2.4 Athletic Ground Symbols

The athletic ground is a piece of land used for different sports such as cricket, basketball, football, volleyball, baseball, etc. Different sports require different styles, shapes, and sizes of the ground.

That is why a Sports ground needs to be mapped on a Floor Plan. Sports grounds are built outside many buildings, malls, and societies. These are illustrated in building plans because these are a part of the whole project. There are different symbols used to represent athletic grounds.

Athletic Ground 1	Athletic Ground 2	Athletic Ground 3
		
Athletic Ground 4		
		











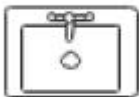
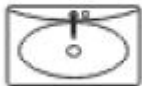





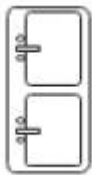

Source: EdrawMax













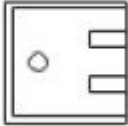
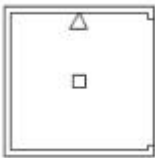
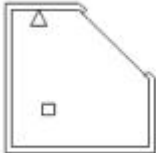

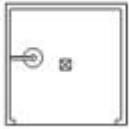

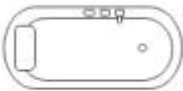
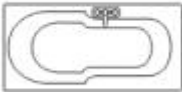
2.5 Bathroom Symbols



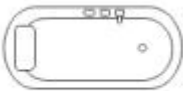
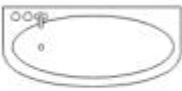

















A [bathroom symbols](#)⁴ are the room that has a toilet, shower, washbasin, and bathtub. Many homeowners consider the bathroom a place to get away from stress and anxiety. It is a place

⁴ Bathroom symbols: <https://www.edrawsoft.com/symbols/bathroom-vector-icons.html>

where you can relax, take a soothing shower, bathe in hot tub water and be alone. It serves basic hygiene and cleaning functions and is also used to relax, wash, and change clothes.

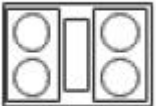
Sink 1	Sink 2	Sink 3
		
Sink 4	Sink 5	Sink 6
		
Sink 7	Sink 8	Sink 9
		
Sink 10	Sink 11	Sink 12
		
Countertop Sink	Pedestal Sink	Toilet 1
		
Toilet 2	Toilet 3	Toilet 4
		
Toilet 5	Toilet 6	Square WC
		









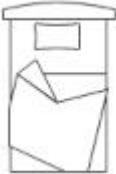
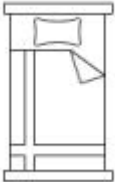
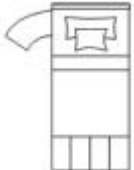

		
Shower	Corner Shower	Corner Bath
		
Bathroom	Bathtub 1	Bathtub 2
		
Bathtub 3	Bathtub 4	Bathtub 5
		
Bathtub 6	Bathtub 7	Bathtub 8
		
Bathtub 9	Bathtub 10	Bathtub 11
		
Bathtub 12	Shower Drain	Shower Drain 2
		
Water Tap 1	Water Tap 2	Water Tap 3

		
Water Tap 4	Water Tap 5	Dustbin
		
Toilet Paper	Towel Rack	Towel Rack 2
		
Light 1	Light 2	Light 3
		
Light 4	Shower Lamp 1	Shower Lamp 2
		
Shower Lamp 3	Shower Lamp 4	Shower Lamp 5
		
Cabinet 1	Cabinet 2	Cabinet 3
		

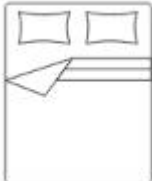
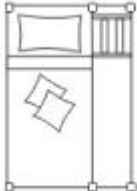
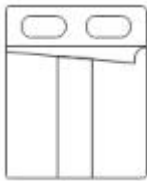
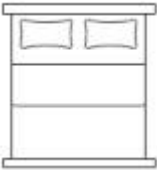
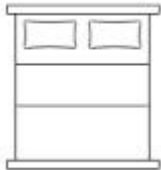
Source: EdrawMax

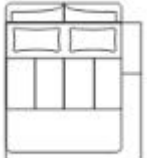

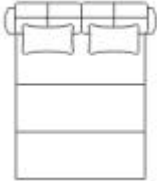
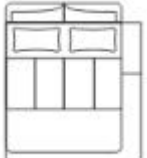

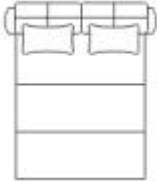





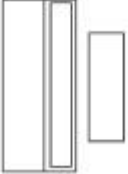

2.6 Bedroom Symbols

A bedroom is where the residents live, rest, and sleep. That is why a bedroom should be pleasantly decorated for your comfort and healthy sleeping. **Bedroom symbols⁵** usually matched the theme and style. Numerous elements are included in bedding category symbols such as bed set, side drawers, plants, windows, curtains, cabinets, dressing table, carpet, pillow, chest, flat panel.

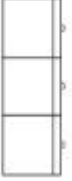
Single Bed 1	Single Bed 2	Single Bed 3
		
Single Bed 4	Single Bed 5	Single Bed 6
		
Single Bed 7	Single Bed 8	Double Bed 1
		
Double Bed 2	Double Bed 3	Double Bed 4
		
Double Bed 5	Double Bed 6	Double Bed 7
		
Double Bed 8	Single Trundle Bed	Bunk Bed
		

⁵ Bedroom symbols: <https://www.edrawsoft.com/bedroom.html>

		
Bunk Bed 2	Crib	Bassinet
		
Vanity Table	Night Stand	Circular Bed
		
Circular Bed 2	Circular Bed 3	Circular Bed 4
		
Circular Carpet	Carpet	Carpet 2
		
Bedside Cabinet	Rectangle Table	House Plant 1
		
House Plant 2	House Plant 3	House Plant 4
		
House Plant 5	Flat-Panel TV	Spinet Piano

		
Bookcase	Pillow	Chest
		
Double Dresser	Tripper Dresser	Cabinet 1
		
Cabinet 2	Wardrobe 1	Wardrobe 2
		
Shoe Cabinet 1	Shoe Cabinet 2	
		















Source: EdrawMax

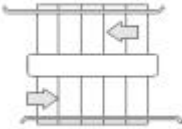
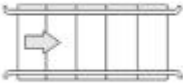
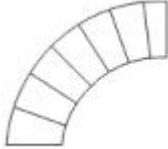
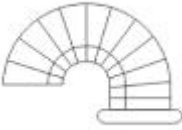
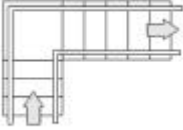
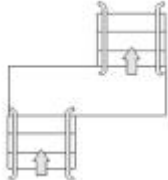
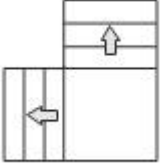









2.7 Building Core Symbols

Many designs and layouts are considered while planning for building construction. These construction styles carry some common elements used in almost every business plan. Every company has its own designed floor plan symbols. But some **building core symbols**⁶ are slightly redesigned but serve the same purpose. They can be altered according to shapes, size, dimensions, and uses.

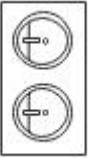
North	Direction	Arrow
-------	-----------	-------

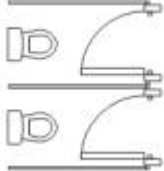
⁶ Building core symbols: <https://www.edrawsoft.com/building-core.html>

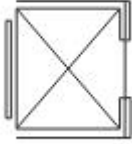
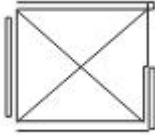
		
Air-Conditioned Location	Solid Walls	Step
		
Ornamental Stair	Scissor Staircase	Straight Staircase
		
Curved Staircase 1	Curved Staircase 2	Winding Staircase
		
Z-Shape Staircase	Divided Staircase	Pocket Door
		
Double Pocket Door	Left Spiral Staircase	Right Spiral Staircase
		
Corner Landing	Stair Landing	Escalator
		
Ramp	Handrail	Corner Handrail

		
Toilet	Mult Sink	Mult Urinal
		
Mult Stall	Countertop Sink	Toilet Stall
		
Elevator	Freight Elevator	Chute
		

Source: EdrawMax













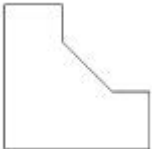
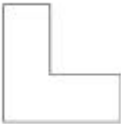

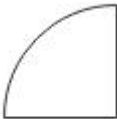



2.8 Cabinet and Bookcases Symbols

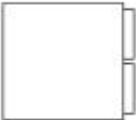











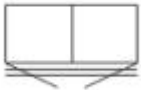

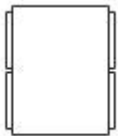

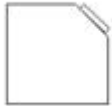
The cabinets are installed in many rooms to store and keep clothing, valuables, and other stuff. It is the main component of a wardrobe. All the clothes and accessories are stored and usually hung in a cabinet. There are numerous symbols for a wardrobe according to its types, size, dimension, and styles. There are three types of cabinets: partial overlay, full overlay, and inset.

A bookcase is a piece of furniture with shelves used to keep and display books. Usually, its design is customized according to the number of books and room space. According to its placement and structure, bookcase symbols are used in a floor plan. There are many bookcase types, i.e., standard, cube, modular, leaning, corner, and barrister. Learn more details about [cabinet symbols](https://www.edrawsoft.com/home-plan-symbols.html)⁷ guide here.

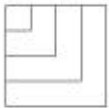
Work Surface	Corner Surface	Corner Surface 2
--------------	----------------	------------------

⁷ Cabinet symbols: <https://www.edrawsoft.com/home-plan-symbols.html>

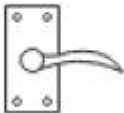





		
Corner Surface 3	Corner Surface 4	Island
		
Corner Counter	Platter Counter	Bevel Counter
		
Bent Counter	Work Peninsula	Base
		
Base 2	Base 3	Base 4
		
Base 5	Base 6	Drawer
		
Drawer 2	Drawer 3	Drawer 4
		
Cabinet	Cabinet 2	Cabinet 3

		
Cabinet 4	Peninsula End-Shelf	Base Peninsula
		
Base Peninsula 2	Wall End-Shelf	Wall Corner
		
Wall Angle Cabinet	Track End-Bevel	Track 45 Deg
		
Track Corner	Tray Track	Locker
		
Handle	Handle 2	Handle 3
		
Handle 4	Handle 5	
		

Source: EdrawMax

2.9 Carpet Symbols

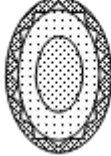
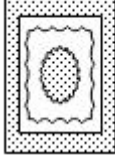
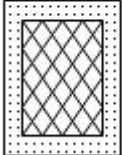
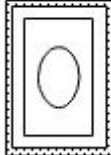
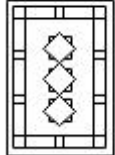
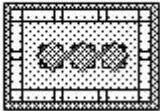
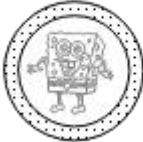
Carpet is a floor covering made of thick woven fabric, and it complements the room's look by its color, print, and design. It is used for many reasons, such as preventing feet from getting cold, making the room cozy, and getting a place to sit on the floor. Following symbols are used for carpet representation in a floor plan.

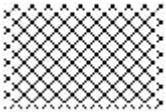
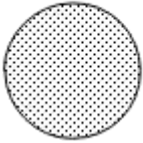
Carpet 1	Carpet 2	Carpet 3
		
Carpet 4	Carpet 5	Carpet 6
		
Carpet 7	Carpet 8	Carpet 9
		
Carpet 10	Carpet 11	Carpet 12
		
Carpet 13	Carpet 14	
		















Source: EdrawMax

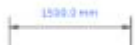



2.10 Dimensioning Symbols

Dimension symbols provide the construction team and management with all the true and exact dimensions, sizes, measurements, and calculations of the tasks and

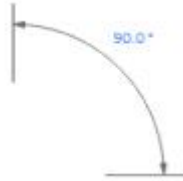
building. These symbols add size information in a drawing to help the construction team understand the building procedures and diagram.

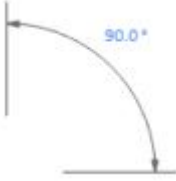
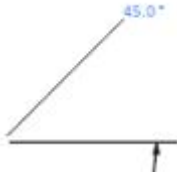
The dimensions on a plan are mentioned to tell if the doors, windows, stairs, pillars, walls, columns, and sections are located correctly. The dimension lines are lighter than wall lines and are generally denoted as a continuous group or string of numbers along a line. Dimensions give definite directions to the construction personnel from beginning to end.

Dimension 1	Dimension 2	Dimension 3
		
Dimension 4	Dimension 5	Dimension 6
		
Dimension 7	Dimension 8	Dimension 9
		
Dimension 10	Dimension 11	Dimension 12
		
Dimension 13	Dimension 14	Dimension 15
		
Dimension 16	Dimension 17	Dimension 18

		
Dimension 19	Dimension 20	Dimension 21
		







Source: EdrawMax

2.11 Fire and Emergency Symbols













This category includes equipment used in case of a fire emergency. Symbols elaborate all these equipment. Fire and emergency symbols provide health and safety information and warn about hazards. Fire evacuation symbols, fire hose, fire extinguisher, emergency exit, elevator, and fire hydrant. These symbols are as follows:

- **Access and Exit Icons**

During an emergency, the **access and exit icons**⁸ graphically indicate safe routes, safety exits, and access points that everyone can use. These evacuation plan icons are quite useful because they can be used to indicate all of the entry and exit points in the house or building, as well as how to open various doors, shatter windows and glass during crises, and where disabled persons should depart. People can identify multiple escape routes in an emergency using these symbols. Here are several icons for access and exit.

Slide Door Left	Slide Door Right	Fire Break Glass
		
Emergency Ambulance	Emergency Access	Emergency Access 2
		
Emergency Exit	Emergency Exit 2	Use Stairs in Fire



⁸ Access and exit icons: <https://www.edrawsoft.com/symbols/fire-evacuation-icons.html>

		
Use Stairs	Fire Ladder	Handicap Accessible
		
Arrow	Indicating Arrow	Indicating Arrow 2
		
Indicating Arrow 3	Assembly Point	Refuge Area
		





















Source: EdrawMax







• Fire Evacuation Icons

Fire evacuation icons⁹ are ideal for creating a fire escape strategy for your building or home. A fire escape plan usually comprises icons that show at least two emergency exits in a room, a safe departure route, and fire extinguisher locations. These also provide information on the fire alarm and smoke detection systems installed in the building or home. Anyone may determine the location of the emergency phone, sprinklers, and fire hose using a fire evacuation plan. The following are some frequent fire-evacuation icons.

You are Here	Fire Emergency Exit	Fire Emergency Exit 2
		
Fire Extinguisher	Fire Hydrant	Fire Hydrant 2

⁹ Fire evacuation icons: <https://www.edrawsoft.com/symbols/fire-evacuation-icons.html>



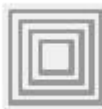



		
Emergency Phone	Emergency Phone 2	Call 911
		
Fire Extinguisher 2	Fire Alarm Call Point	Fire Hose
		
Fire Hose 2	Gas Shutoff Valve	Sprinkler Control Valve
		
Sprinkler Connection	Single Sprinkler Connection	Combined Automatic Sprinkler
		
Standpipe Connection	Fire Axe	Fire Fighting Equipment
		
Alarm	Fire Alarm	Manual Activating Device
		
Electric Panel Shutoff	Child Care Center	Smoke Detector

		
Fire Sprinkler	Fire Sprinkler 2	Air Conditioning Vent
		
Vent		
		

















Source: EdrawMax

• **Emergency Warning Icons**

In an evacuation plan, [warning symbols¹⁰](#) describe dangerous things, locations, behaviors, and materials. We utilize these evacuation plan icons to alert individuals to dangers such as radiation, fire hazard, no smoking, and electric current in their environment. Because the law primarily regulates warning symbols, and each symbol has a fixed meaning that you cannot change, they are universal for all organizations. These icons advise individuals about the activities they can't do and the objects they can't touch in an evacuation plan. Here are some cautionary signs.

Not an Exit	Don't Go Back	Don't Use the Elevator
		
No Fire	No Smoking	No Cooking
		
Radiation Hazard	Non-ionising Radiation	Explosives

¹⁰ Warning symbols: <https://www.edrawsoft.com/symbols/fire-evacuation-icons.html>

		
Toxic Gas	Medical Waste	Flammable Material
		
Comburent	Dangerous Chemical	Corrosive Material
		
Noise	Be Careful Suffocation	Harmful Goods
		
Chemical Weapon	Warning Sign	High Voltage Sign
		
Laser Hazard Sign	Radiation Danger	
		

Source: EdrawMax



















2.12 Garden Symbols

A garden in a house or a building is a place that is most connected to nature and beauty. A garden in a building plan is drawn with the help of several garden symbols. These symbols denote plants, pools, fountains, tables, chairs, benches, pavilions, rocks, ponds, etc. Garden Symbols cover all types of plans as well.





















Garden symbols¹¹ denote plants, pools, fountains, tables, chairs, benches, pavilions, rocks, ponds, etc. But plants among this list carry the most importance. That is why all sorts of plants are symbolized in a garden plan.





















• **Garden Plant Symbols**





Plants are the main element of a garden. They allow a person to breathe in the clean and fresh air, block sunrays, decrease noise pollution, provide a peaceful environment, and lower stress. That is why a garden's idea was first introduced.

Evergreen Tree 1	Evergreen Tree 2	Evergreen Tree 3
		
Evergreen Tree 4	Evergreen Tree 5	Evergreen Tree 6
		
Evergreen Tree 7	Evergreen Tree 8	Evergreen Tree 9
		
Evergreen Tree 10	Deciduous Tree 1	Deciduous Tree 2
		
Deciduous Tree 3	Deciduous Tree 4	Deciduous Tree 5
		
Deciduous Tree 6	Deciduous Tree 7	Deciduous Tree 8
		

¹¹ Garden symbols: <https://www.edrawsoft.com/garden-design-symbols.html>

		
Deciduous Tree 9	Deciduous Tree 10	Shrub 1
		
Shrub 2	Shrub 3	Shrub 4
		
Shrub 5	Shrub 6	Shrub 7
		
Shrub 8	Flower 1	Flower 2
		
Flower 3	Flower 4	Flower 5
		
Flower 6	Flower 7	Flower 8
		
Flower 9	Flower 10	Flower 11











		
Flower 12	Flower 13	Flower 14
		
Flower 15	Flower 16	Flower 17
		
Flower 18	Flower 19	Flower 20
		
Flower 21	Flower 22	Flower 23
		
Flower 24	Ornamental Grass 1	Ornamental Grass 2
		
Ornamental Grass 3	Ornamental Grass 4	Ornamental Grass 5
		
Ornamental Grass 6	Ornamental Grass 7	Ornamental Grass 8

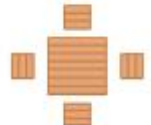

















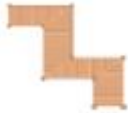

		
Ornamental Grass 9	Ornamental Grass 10	
		



















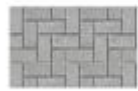

Source: EdrawMax



















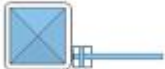

• **Garden Equipment Symbols**

A garden not only needs plants to fulfill its whole look, but it also needs some add-ons to make it look aesthetic. These additions to the garden complete the whole idea by adding minor and major details. Garden symbols represent all these equipment and elements in a map. It may be a bridge installed over a pond or a bench placed on any corner. The infrastructure elements of a garden are bench, chair, pathway and so on.

Stone Table & Chair 1	Stone Table & Chair 2	Stone Table & Chair 3
		
Wood Table & Chair	Swing Bench	Recliner Bench 1
		
Recliner Bench 2	Wood Bench 1	Long Bench
		
Wood Bench 2	Wood Bench 3	Seven Glyph Bench 1
		

		
Seven Glyph Bench 2	U-Shaped Bench	Stone Bridge 1
		
Stone Bridge 2	Timber Bridge 1	Timber Bridge 2
		
Timber Bridge 3	Wooden Bridge	Bridge
		
River Bridge	Garden Lamp 1	Garden Lamp 2
		
Garden Lamp 3	Garden Lamp 4	Stone Road
		
Cobbled Roadway	Rock Garden	Road Path 1
		
Road Path 2	Road Path 3	Garden Stone 1

		
Garden Stone 2	Garden Stone 3	Round Stone
		
Square Stone	Flagstone	Hexagon Stone
		
Stone Driveway	Brick Pathway	Patio Pathway
		
Swimming Pool 1	Swimming Pool 2	Swimming Pool 3
		
Fountain Pool 1	Fountain Pool 2	Fountain Pool 3
		
Fountain Pool 4	Fountain Pool 5	Fountain Pool 6
		
Fountain Pool 7	Fountain Pool 8	Pond 1

		
Pond 2	Pond 3	Pond 4
		
Pond 5	Swimming Ring 1	Swimming Ring 2
		
Umbrella 1	Umbrella 2	Duty Room
		
Wood Post	Pavilion	Garbage Can 1
		
Garbage Can 2	Play Ground	Flower Bed
		
Fitness Equipment 1	Fitness Equipment 2	Fitness Equipment 3
		
Fitness Equipment 4	Children Play Area	

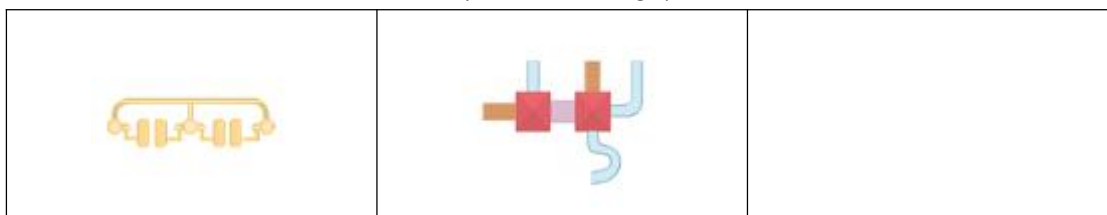













Source: EdrawMax











2.13 HVAC Symbols

We use various **HVAC symbols**¹² to design schematic wiring and circuit diagrams to depict the layout and working mechanism of HVAC systems. Selecting the symbols to use in the HVAC plan depends on the building or house configurations and the owner's desire. Some of the universal symbols used in all HVAC plans are the ducts, air-filters, supply fans, electrical devices, and controls. We categorize HVAC symbols into four types based on their purpose, designs, and type of building. Here are the four types of HVAC symbols.

- HVAC Controls Symbols

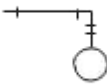
Temperature	Humidity	Enthalpy
		
Pressure	Flow	Velocity
		
Voltage	Current	Rotation
		
Light	Vibration	Timer
		

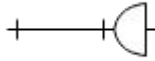

¹² HVAC symbols: <https://www.edrawsoft.com/hvac-plan-symbols.html>







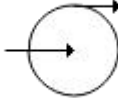



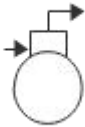





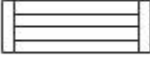

Current	Power	Air quality
		
Level	End switch	Smoke
		
Power connection	I/O point	Actuator
		
Connector line	Label	
	Text	







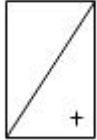
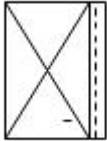
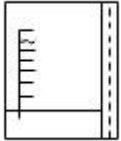





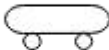

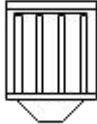





Source: EdrawMax









• HVAC Equipment Symbols

The HVAC equipment symbols depict the electrical products, devices, and equipment used to connect them with the HVAC system. We use these HVAC symbols to visually represent all the major and minor components and products in an HVAC plan. The equipment includes common devices, such as fans and air filters for better quality airflow. It also includes outer products such as DX units and driers. You need a basic knowledge of these symbols before creating an HVAC plan. Here are some HVAC equipment symbols.

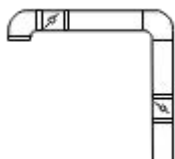
Pump	Rotary pump	Centrifugal pump
		
Reciprocating pump	Screw pump	Fan

		
Centrifugal fan	Fan blades	Moisture eliminator
		
Silencer	Silencer 2	Condenser
		
Air filter	Drier	Pipe coil
		
Exhaust hood	Muffler	Air volume control valve
		
Filter	Regulator	Heater
		
Surface air cooler	Humidifier	High efficiency filter
		
Ozone generator	Primary filter	Air compressor

		
Oxygen-enriched filter	Ozone generator	Membrane clear box
		
Vacuum pump	Valve	Vacuum Gauge
		
Steam separator	Pressurizer system	Dehumidifying system
		
Booster fan	Preheating system	Nozzle
		
Boiler	Cold water pump	Flow valve
		
Water tower	Supply air grill	Pipe network
		
Cooling coil	Return air grill	Pipeline

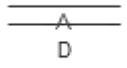







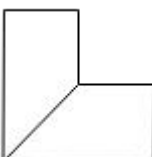
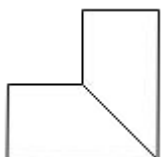

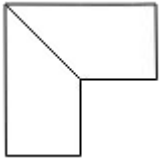
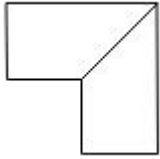



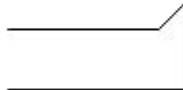

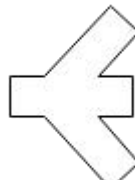
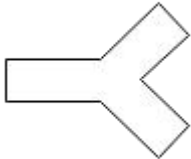
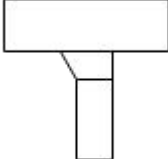
		
Zone damper	Outside air duct	Ventilator
		
Refrigerant receiver	Chiller	Axia fan
		
Access door		
		

Source: EdrawMax

• HVAC Ductwork Symbols

The **HVAC ductwork** is an essential part of central HVAC systems. We use ductwork symbols to illustrate the ducts and Vav boxes in an HVAC plan. Most ductwork symbols are mainly represented by one or two lines in a rectangular shape. We use ducts for thermal and acoustic reasons for increasing and decreasing heat or cold.

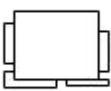









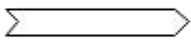

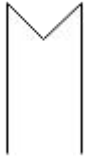

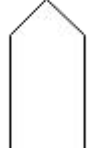
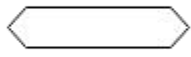
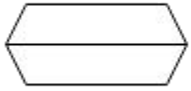
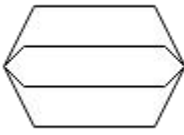
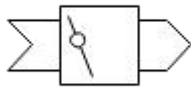
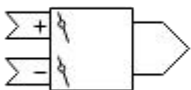
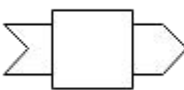
Straight duct	Miter bend	Miter bend 2
		
Miter bend 3	Miter bend 4	Variable bend



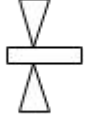









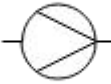

		
Variable bend 2	Branch duct	Branch duct 2
		
Junction bottom	Junction up	3 way junction
		
Y junction	Beveled junction	Transition
		
Offset transition	Supply	Return
		
Flexible connection 1	Flexible connector	Vertical duct
		
VAV box	Sliding damper	Damper
		

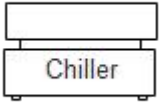
Source: EdrawMax

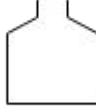
• HVAC Controls and Equipment Symbols

HVAC control and equipment symbols depict the devices and systems with control features such as a propeller fan with a speed regulator. These are the common symbols used in all types of HVAC plans. Most of these symbols represent products with fans and controllers.

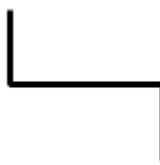
Duct	Return Duct	Return Duct 2
		
Supply Duct	Supply Duct 2	2-Fan Sections
		
3-Fan Sections	4-Fan Sections	VAV Box
		
DD VAV Box	Fain Coil Housing	Unit Heater
		
Centrifugal Fan	Propeller Fan	Vane Axial Fan
		
Damper	Filter	Air Flow Station
		
Humidifier	Htg/Clg Coil	Pump
		

		
Valve	Gate Valve	Water Flow Meter
		
Chiller	Cooling Tower	Boiler
		
Equipment	VSD	Start
		
Side to Side Pipe	Top to Bottom Pipe	Side to Bottom Pipe
		
Pipe Flow Arrow		
		







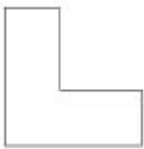

Source: EdrawMax

2.14 Kitchen and Dining Room Symbols



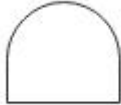



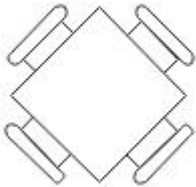
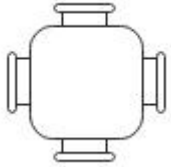
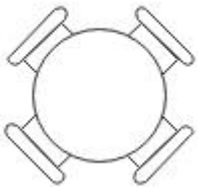
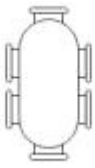
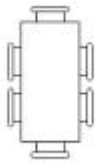
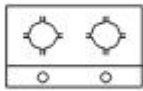



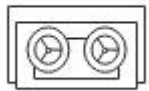

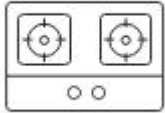
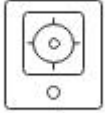
A kitchen is a room or a part of a room used to prepare and cook food, and it is part of a building that gets most of the attention from the buyer or an architect. Kitchen symbols represent refrigerators, crockery, microwave oven, stove, ventilators, dishwashers, steamers, teapots, gas-cookers, etc. The kitchen elevation plan shows how beautiful and manageable

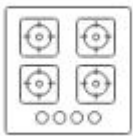
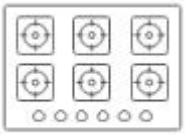
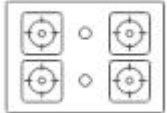

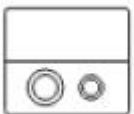
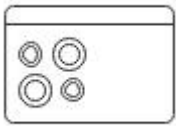
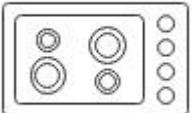
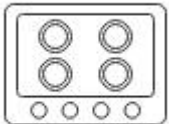





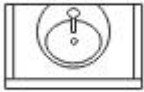



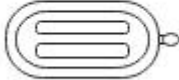

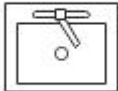
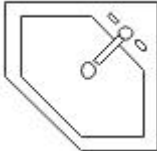
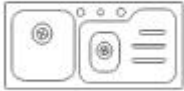
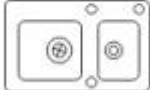
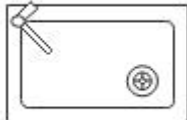
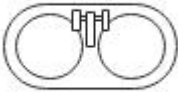
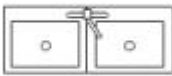
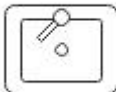
your kitchen looks at the end. Today kitchen designing has become a separate discipline in the designing world.

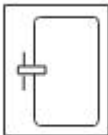



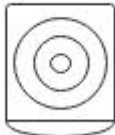

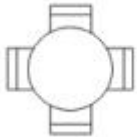



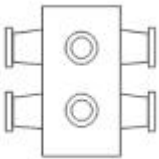
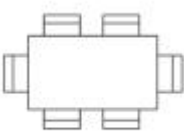
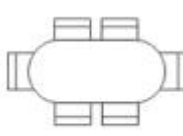
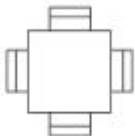

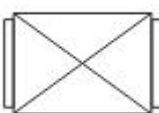

The dining room is where all the meals are served and eaten. A dining room contains many items which are related to mealtimes. The [kitchen floor plan symbols¹³](#) include window symbols, bottles symbols, Glass symbols, barrel symbols, dining table symbols, Table and chair set symbols.

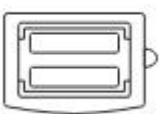

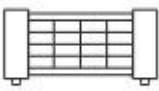
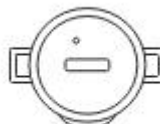
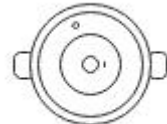





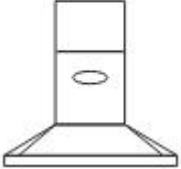
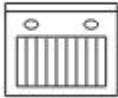

Closet 1	Closet 2	Closet 3
		
Closet 4	Closet 5	Closet 6
		
Closet 7	Island	Island 2
		
Square Dining Table	Square Dining Table 2	Round Dining Table
		
Rectangle Dining Table	Rectangle Dining Table 2	Gas Stove
		
Gas Stove 2	Gas Stove 3	Gas Stove 4

¹³ Kitchen floor plan symbols: <https://www.edrawsoft.com/symbols/kitchen.html>

		
Gas Stove 5	Gas Stove 6	Range with Grill
		
Four-Element Gas Range	Six-Element Gas Range	Gas Range
		
Cooker with Low Oven	Cooker	Range
		
Flat Electric Range	Slide-in Electric Range	Wall Oven
		
Microwave	Dishwasher	Washing Machine
		
Trash Compactor	Food Cooler	Sink
		
Juicer	Bread Machine	Bread Machine 2

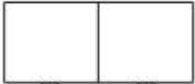
		
Vending Machine	Sink 2	Sink 3
		
Sink 4	Sink 5	Sink 6
		
Sink 7	Sink 8	Sink 9
		
Sink 10	Basin	Double Basin
		
Pedestal Basin	Countertop Sink	Dispenser
		
Towel Rack	Circular Dining Table	Circle Table
		
Dining Table	Oblong Dining Table	Oval Dining Table

		
Square Table	Ref	Ref 2
		
Cabinet	Cabinet 2	Cabinet 3
		
Toaster	Toaster 2	Oven
		
Electric Barbecue	Sauce Pan	Sauce Pan 2
		
Slow Cooker	Slow Cooker 2	Induction Cooker
		
Pan	Dish	Dish 2
		
Fruit Plate	Fruit Plate 2	Chopping Board

		
Smoke Machine	Disinfection Cabinet	Refrigerator
		
Refrigerator 2	Flue	Placement
		
Chest Freezer	Built-in Refrigerator	Water Cooler
		
Coffee Maker	Water Heater	
		

Source: EdrawMax

2.15 Office Symbols















It is a room or building used as a place for commercial, professional, or bureaucratic work. It provides a workplace to do administrative and managerial work. Workers and employees work in an office, and they are given their desk, PC, chair, and other office appliances. An office floor plan is designed by using the following symbols, and learn more details from this [office symbols¹⁴](#) guide.





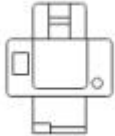

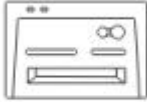
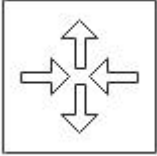
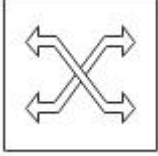

• Office Equipment Symbols

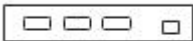
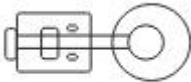
Electronic goods that employees use in the office for communication, work, recording, supplies storage, and data are included in the **office equipment symbols**. Computers,

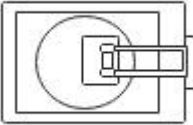
¹⁴ Office symbols: <https://www.edrawsoft.com/office-layout-symbols.html>

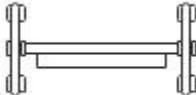
monitors, laptops, fax machines, printers, scanners, telephones, air conditioners, and any other office items are represented by office equipment symbols.

Desktop PC	PC	Phone
		
Mobile Phone	Fax	PC Monitor
		
Keyboard	Tower PC	Mouse
		
Modem	Scanner	Printer
		
Xerox	Plotter	Document Shredder
		
Router	Switch	Wireless Hub
		
Hub	Office Lamp	Projector

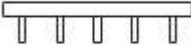
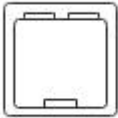







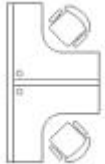
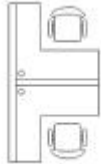

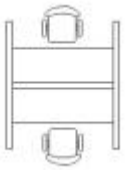
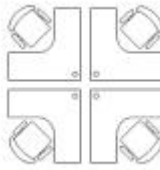
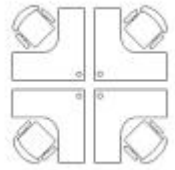
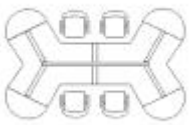

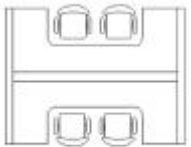
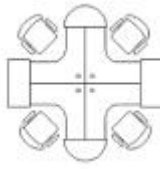
		
Overhead Projector	Projector Screen	Marker Board
		
Plasma Panel	Cash Register	POS-Terminal
		
Paper Tray	Coat Rack	Waste Can
		

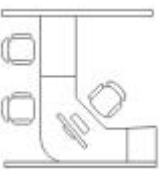

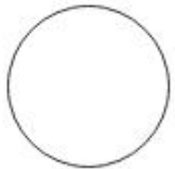



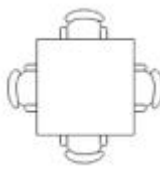
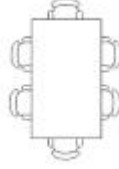
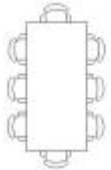



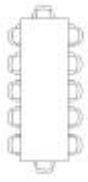

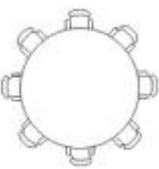

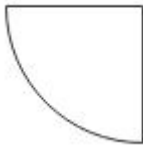

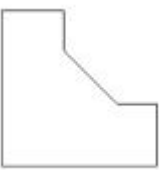
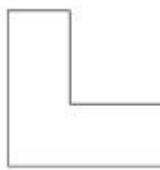

Source: EdrawMax











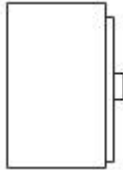
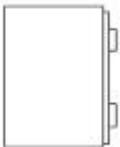
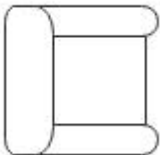

• Office Furniture Symbols

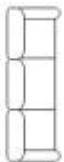
Electronic goods that employees use in the office for communication, work, recording, supplies storage, and data are included in the office equipment symbols. Computers, monitors, laptops, fax machines, printers, scanners, telephones, air conditioners, and any other office items are represented by **office equipment symbols**.

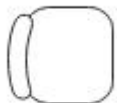
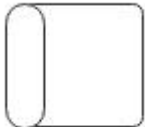
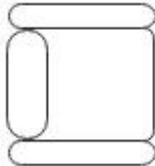
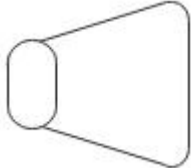
Single Cubicle	2 Seats Cubicle	2 Seats Cubicle 2
		
2 Seats Cubicle 3	Cubicle 1	Cubicle 2

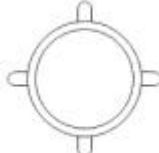
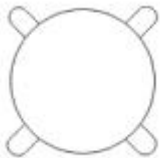
		
Cubicle 3	Cubicle 4	Cubicle 5
		
Cubicle 6	Cubicle 7	Straight Workstation
		
Council Workstation	L Workstation	Table
		
Round Table	Desk	Racetrack Table
		
Boat Table	4 Seats Table	6 Seats Table
		
8 Seats Table	10 Seats Table	10 Seats Table 2
		
10 Seats Table 3	12 Seats Table	16 Seats Table

		
Multi-chair Round Table	Corner Table	Round Corner
		
Work Surface	Conner Surface	Conner Surface 2
		
Conner Surface 3	Conner Surface 4	Work Peninsula
		
Book Shelf	Credenza	Pedestal
		
Cabinet	Cabinet 2	Cabinet 3
		
Storage Unit	Susp Coat Bar	Susp Open Shelf
		
Suspended Lateral File	File	Lateral File

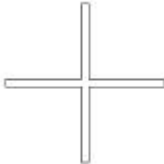
		
Flat File	Swivel Tilt Chair	2 Seat Sofa
		
3 Seat Sofa	4 Seat Sofa	90 Deg Table
		
Chair 1	Chair 2	Chair 3
		
30 Deg Seat	Desk Chair	High Stool
		
Stool	Panel	2 Panel
		
3 Panel	4 Panel	Cross Panel
		

Source: EdrawMax













2.16 Plumbing and Piping Symbols

Plumbing is a system that conveys and directions water/gas through pipelines installed in a house or a building. It involves using pipes, valves, plumbing fixtures, tanks, and other equipment. Piping and connection symbols denote all the pipeline types and connectors. Piping or tubing is usually inserted into fittings to form connections. Pipe connectors are used to attach one pipe to another to increase the length of the pipe or to change the direction of flow of a plumbing system. Learn more details from this [plumbing & piping symbols¹⁵](#) guide.

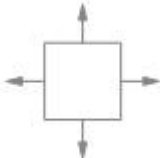











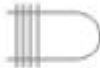

• Plumbing Symbols

There are listed some common plumbing symbols with relative explanations:

- **Boiler:** is a fuel-burning apparatus or container for heating water.
- **Heat exchanges:** used to transfer heat efficiently from one medium to another.
- **Heating coil:** a special heating device that is shaped in a spiral design.
- **Pump:** a mechanical device using suction or pressure to raise or move liquids, compress gases, or force air into inflatable objects such as tyres.
- **Heater:** a device for warming the air or water.

Boiler	Boiler 2	Heat Exchanges
		
Heating / Cooling Coil	Heating / Cooling Coil	Pump
		
Pump 2	Heater / Cooler	Heater / Cooler Horizontal
		
Radiator	Convactor	Radiant Panel
		

¹⁵ Plumbing & piping symbols: <https://www.edrawsoft.com/plumbing-piping-plan-symbols.html>



















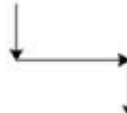

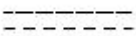
Radiant Panel 2	Open Tank	Closed Tank
		
Water Surface	Pipe Coil	Sink
		
Basin	Toilet	Bath
		
Basin (Side)	Toilet (Side)	Bath (Side)
		
End View	Shower Head	Towel Rail
		

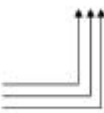

















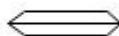

Source: EdrawMax







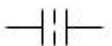













• Piping Symbols





















There are listed some common plumbing symbols with relative explanations:













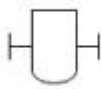



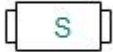



- **Major pipeline:** a long major pipe, typically underground, for conveying fluid or gas over long distances.
- **Battery limit line:** the line which shows the battery limit.
- **Electronic serial:** the serial for the electronic devices.
- **Heat trace:** a kind of system used to maintain or raise the temperature of pipes and vessels.
- **Electric signal:** an electric current or electromagnetic field used to convey data from one place to another.

Major Pipeline	Connect Pipeline	Major Straight Pipeline
		
Straight Line Pipe	Process Connection	Future Line
		
Battery Limit Line	Side by Side	Top-Bottom
		
One-to-Many	Traced Line	Multi-Lines
		
Mid Arrow	Multi-Lines Elbow	Top to Top
		
Electrical Signal	Sonic Signal	Nuclear
		
Pneumatic Control	Pneumatic Binary Signal Line	Electric Signal Line
		
Electric Binary Signal Line	Electric Binary Signal Line 2	Hydraulic Signal Line

		
Sleeve Joint	General Joint	Butt Weld
		
Welded Connection	Mecanical Link	Soldered / Solvent
		
Double Containmentment	Flange	End Caps
		
End Caps 2	Breather	Drip Pan Elbow
		
Flange	Union	Socked Weld
		
Screwed Connection	Orifice Plate	Flanged Dummy Cover
		
Electrical Bounded	Slope Requirement Line	Reducer

		
Electrically Insulated	In-Line Mixer	Seperator
		
Bursting Disc	Flame Arrester	Drain Silencer
		
Exhaust Silencer	Strainer	Exhaust Head
		
Triangle Seperator	Triangle Seperator 2	Tundish
		
Open Vent	Syphon Drain	Hyrant
		
Swivel Joint	Expansion Joint	Hose
		
Flexible Hose	Flow Indicator	Bell Mouse

		
Removable Spool	Basket Strainer	Breather
		
Damper	Breakthrough	Orifice
		
Clamped Flange Coupling	Compensate	Coupling
		
Y-Type Strainer	Y-Strainer	Diverter Valve
		
Blind Disc	Spectacle Blind	Interchangeable Blind
		
Open Disc	Orifice Plate	Pulsation Dampener
		
Duplex Strainer	Vent Silencer	Basket Strainer

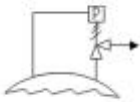
		
Cone Strainer	Detonation Arrestor	Flame Arrestor
		
In-line Silencer	Stream Trap	Desuperheater
		
Eductor	Exhaust Head	Rotary Valve
		
Expansion Joint 2	Bursting Disc	Electrical Insulated
		
Flame Arrestor	Explosion-Proof Flame Arrestor	Detonation-Proof Flame Arrestor
		
Fire-Resistant Flame Arrestor	Fire-Resistant Flame Arrestor 2	Pilot Operated Relief
		
Valve Manifold		

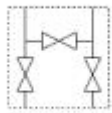
		
---	--	--









Source: EdrawMax



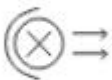















2.17 Reflected Ceiling Plan Symbols

A good lighting design creates depth and height, highlights cozy spots, and diverts attention to your desired areas. Lighting symbols are used where lighting lamps and appliances are installed, such as; the living room, drawing room, bedroom, kitchen, etc.

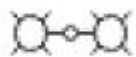
• Reflected Lighting Symbols

In an RCP, **RCP lighting symbols** represent the position of ceiling lights. Emergency light, basic light, modular florescent, downlight, light bar, multi-light bar, and more RCP lighting symbols are included. Before drafting a reflected ceiling plan, you must first establish the components of the ceiling.















Luminaire Ceiling Mount	End Ceiling Lum	Wall Light
		
Downlight	Outdoor Lighting	Multi-Light Bar
		
Batten Flores	Modular Flores	Emerg Light
		
Emerg Sign	Light	Ceiling Light Outlet

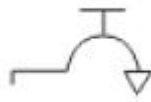





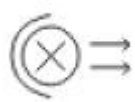

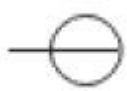



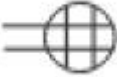



		
Recessed Ceiling Light	Ceiling Fan	Ceiling Fan
		
Weatherproof Light	Ceiling Light 2	Emergency Battery Unit
		
Spotlight	Exit Sign	Light
		
Roadway Light	Twin Lights	Light 2
		
Lights	Integrated Light	Night Light
		
Louvers		
		



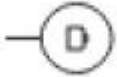

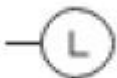

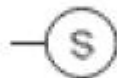
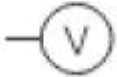

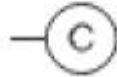

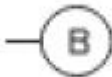









Source: EdrawMax



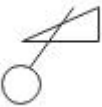



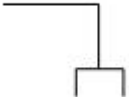













• Electrical & Telecom Symbols

Electrical & telecom symbols are also included in an RCP. These symbols represent the ceiling fan outlets, receptacle outlets, and pull switches. The electrical switch symbols in the ceiling govern the on and off states of stationary devices.

Electrical Switchbox	Single Pole Switch	Three-Way Switch
	S	S₃
1P Switch	2P Switch	4P Switch
		
10P Switch	20P Switch	Water Tap
		
Lum. Ceiling Mount	End Ceiling Lum	Wall Light
		
Circuit Breaker	Multi-Light Bar	Light Bar
		
Downlight	Outdoor Lighting	Singleplex Receptacle
		
Duplex Receptacle	Dishwasher Outlet	Triplex Receptacle Outlet

		
Fourplex Receptacle	Range Outlet	Dryer Outlet
		
Waterproof Receptacle Outlet	Switch and Convenience Outlet	Split Wired Duplex Outlet
		
Split Wired Triplex Outlet	Duplex Special Purpose Outlet	Dishwasher Outlet
		
Drop Cord	Fan Outlet	Junction Box
		
Lamp Holder	Lamp Holder 2	Pull Switch
		
Vapor Discharge	Exit Light Outlet	Clock Outlet
		
Blanked Outlet	TV Outlet	Exhaust Fan

		
Water Heater	Telephone Jack	Electrical Panel
		
Battery	Batten Fluores	Distribution Box
		
Modular Fluores	Office Fluores	Pull-Cord Switch
		
Emerg. Light	Emerg. Sign	Switches
		
Dimmer Switch	Socket Outlet	Socket Outlet 2
		
Telephone Outlet	Stereo Outlet	Ceiling Fan
		
Ceiling Fan 2	Combination Fan	Service Panels

		
Thermostat	Air Conditioning	Open Hold Unit
		
Detector	Fire Alarm	Monitor
		
Alarm	Doorbell	Smoke Detector
		
Household Circuit Breaker Box	Call	Tel
		
Main Control	Ground	Line
		
Wire	Cut Line	Cut Line 2
		

Source: EdrawMax









2.18 Seating Chart Symbols

Seating chairs and tea tables are the most commonly used furniture in any seating chart. Both of these are small and comfortable for all guests. In a social event, you can arrange multiple chairs around a small table where you can serve tea and dessert to the guests.

With these [seating chair icons](#)¹⁶, you can create a schematic representation of how the afternoon tea and food are served at a party or gathering. Teachers use these icons to determine the seating plan of their students in a class. They use sling chairs with a simple design to depict the students' seats and use other symbols to represent windows and walls in the room. Here are a few seating chairs and table icons.\





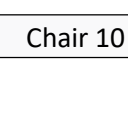
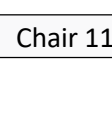
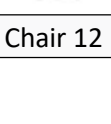



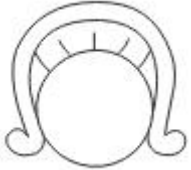

• Table & Chair Symbols

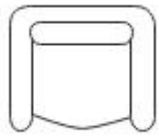
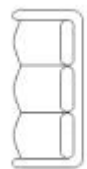
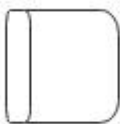
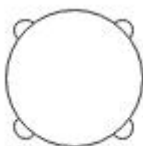
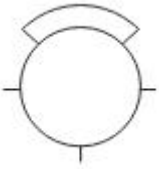

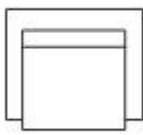

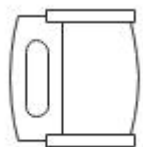
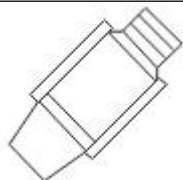
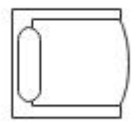

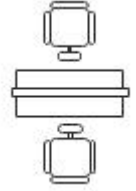
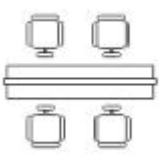

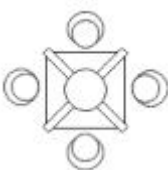
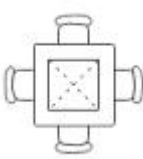

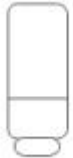
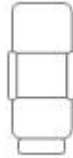

A table is a piece of furniture with a flat top part supporting one or more legs. It is used to write, eat, place things, or do office work. A sofa is a long, foamed seat with a back and arms. Usually, two or three people can sit on a sofa. A chair is a separate seat for only one person, and it usually has a back and four legs. A chair is manufactured in many materials such as wood, iron, and plastic. You can learn more details from [table & chair symbols](#)¹⁷ guide here.

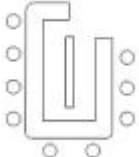

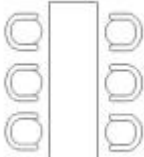





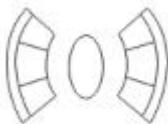
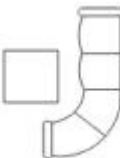
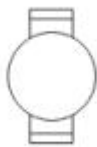
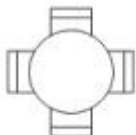
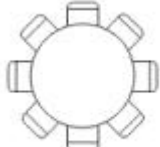
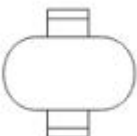
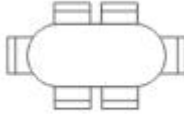

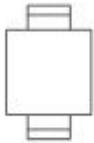
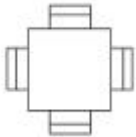
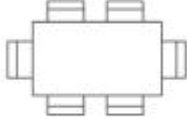
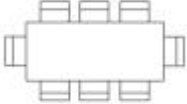
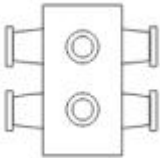





Chair 1	Chair 2	Chair 3
		
Chair 4	Chair 5	Chair 6
		
Chair 7	Chair 8	Chair 9
		
Chair 10	Chair 11	Chair 12
		



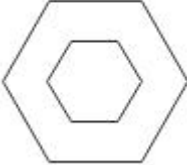

¹⁶ Seating chair icons: <https://www.edrawsoft.com/seating-plan-symbols.html>

¹⁷ Table & chair symbols: <https://www.edrawsoft.com/table-chairs.html>

		
Chair 13	Chair 14	Chair 15
		
Chair 16	Chair 17	Chair 18
		
Chair 19	Chair 20	Recliner
		
Sling Chair	Lounge Chair	Table with Chairs
		
Style Station 1	Style Station 2	Style Station 3
		
Style Station 4	Style Station 5	Style Station 6
		
Style Station 7	Longue Chair 1	Longue Chair 2

		
Longue Chair 3	Longue Chair 4	Longue Chair 5
		
Bar Counter 1	Bar Counter 2	Bar Counter 3
		
Bar Counter 4	Bar Counter 5	Bar Counter 6
		
The Chair & Table 1	The Chair & Table 2	Sofa & Sofa Table 1
		
Sofa & Sofa Table 2	Dining Table 1	Dining Table 2
		
Dining Table 3	Dining Table 4	Dining Table 5
		
Dining Table 6	Dining Table 7	Dining Table 8

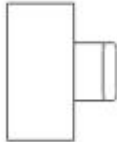
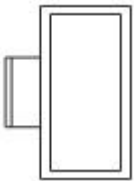

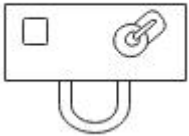
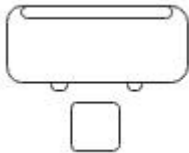

		
Dining Table 9	Dining Table 10	Circle Table & Chair 1
		
Circle Table & Chair 2	Circle Table & Chair 3	Circle Table & Chair 4
		
Circle Table & Chair 5	Circle Table & Chair 6	Circle Table & Chair 7
		
Circle Table	Oval Table	Conference Table 1
		
Conference Table 2	Conference Table 3	Rectangle Table
		
Diamond Table 1	Diamond Table 2	Corner Table
		
Semicircle Table	Fan Table	Ping Pong Table

		
Desk Table 1	Desk Table 2	Desk Table 3
		
Desk Table 4	Dressing Table	
		



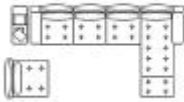



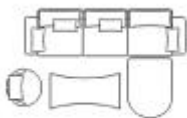



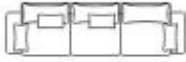

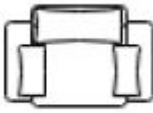
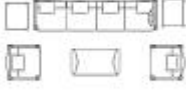
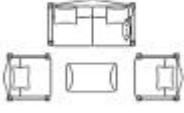
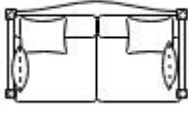
Source: EdrawMax

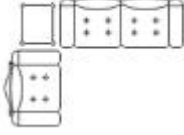

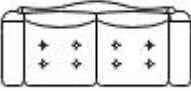
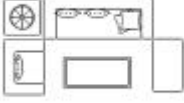
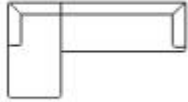
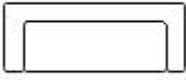

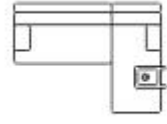
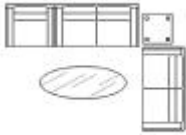
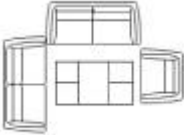
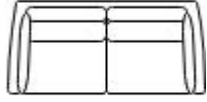







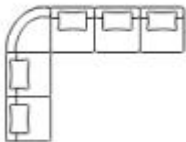
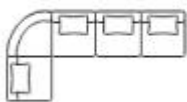

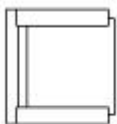
• Sofa Symbols

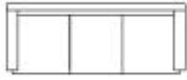

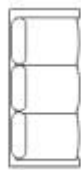
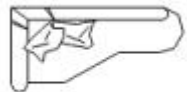

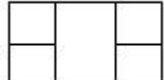
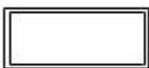

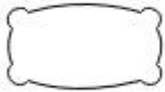

Sofa symbols¹⁸ are mainly used to create seating charts for in-house events and living room furniture arrangements. You can maximize the space in your living room by using various types of sofa arrangements with small coffee tables. You get an endless furniture arrangement idea for your living room and outdoor events using seating sofas. When you arrange sofas, make sure they face the most prominent feature of your room, which can be a flat-screen.

Sofa 1	Sofa 2	Sofa 3
		
Sofa 4	Sofa 5	Sofa 6
		
Sofa 7	Sofa 8	Sofa 9

¹⁸ Sofa symbols: <https://www.edrawsoft.com/table-chairs.html>

		
Sofa 10	Sofa 11	Sofa 12
		
Sofa 13	Sofa 14	Sofa 15
		
Sofa 16	Sofa 17	Sofa 18
		
Sofa 19	Sofa 20	Sofa 21
		
Sofa 22	Sofa 23	Sofa 24
		
Sofa 25	Sofa 26	Sofa 27
		
Sofa 28	Sofa 29	Sofa 30

		
Sofa 31	Sofa 32	Sofa 33
		
Sofa 34	Sofa 35	Sofa 36
		
Sofa 37	Sofa 38	Sofa 39
		
Tea Table 1	Tea Table 2	Tea Table 3
		
Tea Table 4	Tea Table 5	Tea Table 6
		
Tea Table 7	Tea Table 8	Tea Table 9
		
Tea Table 10	Tea Table 11	Tea Table 12

		
Sofa Table 1	Sofa Table 2	Sofa Table 3
		
Sofa Table 4	Sofa Table 5	
		



Source: EdrawMax







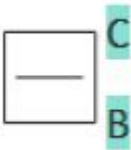

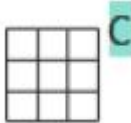









2.19 Security Plan Symbols

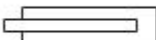
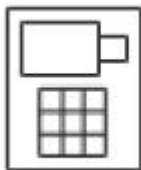
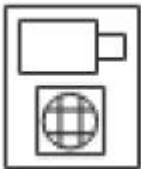
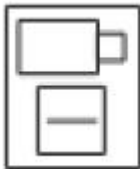





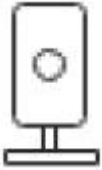

A good lighting design creates depth and height, highlights cozy spots, and diverts attention to your desired areas. Lighting symbols are used where lighting lamps and appliances are installed, such as; the living room, drawing room, bedroom, kitchen, etc.

• Security Camera Symbols

Security managers and IT experts can use the security camera symbols to design a precise layout and wiring diagram for all security cameras in a business or home. Bullet cameras, CCTV cameras, and dome cameras are among the icons. These symbols are intended to assist users in determining which security camera has the least amount of blindsight. Owners may connect these cameras to their phones and monitor security footage while working. It assists the owner and security staff in keeping an eye on the property or building for safety.

Card Access	Biometric Access	Keypad Device
		
Card Reader with Keypad	Card Reader with Time	Smoke Detector

		
Gas Detector	Heat Detector	Turnstile
		
Revolving Door	Traffic Arm	Vehicle Loop Detector
		
Electronic Lock	Exit Device	Camera with Keypad
		
Camera with Intercom	Camera with Card Reader	Security Window Screen
		
Dome Camera	Dome Camera 2	Dome Camera 3
		
Bullet Camera	Bullet Camera 2	Bullet Camera 3
		
Bullet Camera 4	Bullet Camera 5	CCTV Camera 1

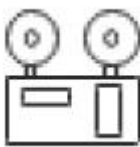
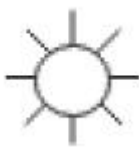
		
CCTV Camera 2	CCTV Camera 3	CCTV Camera 4
		
CCTV Camera 5	CCTV Camera 6	CCTV Camera 7
		
CCTV Camera 8	Emergency Battery	Strobe
		

















Source: EdrawMax

• Video Surveillance Symbols

The video surveillance symbols are the basic elements for drawing the security plan, there are listed some representative symbols:

- **Motion detector:** is a device that detects moving objects, particularly people.
- **Glass break sensor:** is used in electronic burglar alarms that detects if a pane of glass is shattered or broken.
- **Screening device:** is a portable measuring instrument that a police officer can use to gather evidence related to blood alcohol content.
- **Monitor:** is a device used for observing, checking, or keeping a continuous record of something.
- **Recorder:** is an apparatus for recording sound, pictures, or data.

Camera	Motion Detector	Glass Break Sensor
--------	-----------------	--------------------

 490 mm x 240 mm	 490 mm x 490 mm	 490 mm x 490 mm
Screening Device	Monitor	Camera P/T/Z
 1010 mm x 500 mm	 490 mm x 490 mm	 490 mm x 490 mm
Video Multiplexer	Push Button	Recorder
 490 mm x 490 mm	 490 mm x 490 mm	 490 mm x 240 mm
Switch Manual	Switch Automatic	Video Keyboard
 490 mm x 490 mm	 490 mm x 490 mm	 990 mm x 400 mm
Bi-static Beam Sensor	Security Window Screen	Video Motion Detector
 500 mm x 500 mm	 490 mm x 490 mm	 490 mm x 490 mm
Wire Connector		
		

Source: EdrawMax













2.20 Elevation Symbols

A front and clear view of a structure or a house is depicted in an elevation plan, which shows how a construction plan will look after all the details are completed. Elevation plans contain











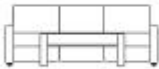

a variety of **elevation symbols**¹⁹ that are simple to grasp and read by anyone who holds them. The ability to demonstrate the interior and exterior elements of a structure is critical because it allows a designer to adjust and change concepts before the project is done.

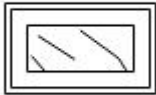
• **Basic Elevation Symbols**

- **Frame:** a rigid structure that surrounds something such as a picture, door, or windowpane.
- **Divider:** something that divides a whole into parts.
- **Drawer:** a box-like storage compartment without a lid, made to slide horizontally in and out of a desk, chest, or other piece of furniture.
- **Lattice:** a structure consisting of strips of wood or metal crossed and fastened together with square or diamond-shaped spaces left between, used as a screen or fence or as a support for climbing plants.
- **Hooks:** pieces of metal or other hard materials curved or bent back at an angle, for catching hold of or hanging things on.

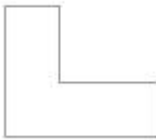
Frame	Frame 2	Divider-H
		
Divider-V	Divider-H 2	Divider-v 2
		
Divider 2	Rect	Door Left
		
Door Right	Door Double	Bedside Cabinet
		
Sofa	Washbasin	Plant

¹⁹ Elevation symbols: <https://www.edrawsoft.com/elevations-symbols.html>









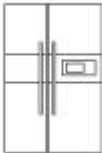
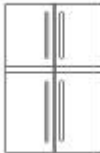







		
Fireplace	Painting	Wall
		
Flue	Table Facet	L Table Facet
		
Drainage Pipe	Outlet	Intake
		













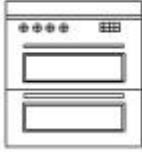
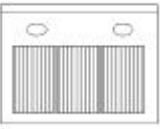

Source: EdrawMax

• Kitchen Elevation Symbols

- **Refrigerator:** a large container which is kept cool inside, usually by electricity, so that the food and drink in it stays fresh.
- **Range hood:** a device containing a mechanical fan that hangs above the stove or cooktop in the kitchen.
- **Gas cooker:** a range with gas rings and an oven for cooking with gas.

Refrigerator 1	Refrigerator 2	Refrigerator 3
		
Refrigerator 4	Refrigerator 5	Refrigerator 6

		
Refrigerator 7	Refrigerator 8	Two-Door Refrigerator
		
Kitchen Ventilator 1	Kitchen Ventilator 2	Kitchen Ventilator 3
		
Kitchen Ventilator 4	Microwave Oven 1	Microwave Oven 2
		
Turner 1	Turner 2	Soup Ladle
		
Kitchen Ware	Teapot	Teacup 1
		
Teacup 2	Teacup 3	Kettle
		
Steamer	Frying Pan	Chafing Dish

		
Sauce Pan	Gas Cooker	Disinfection Machine
		
Disinfection Machine 2	Range Hood	Washer 1
		
Washer 2	Detergent 1	Detergent 2
		
Detergent 3	Shampoo	Shower Cream
		



















Source: EdrawMax

• Wardrobe Elevation Symbols















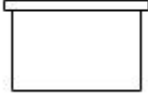
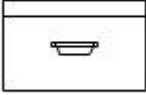
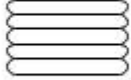



A wardrobe is a cabinet where clothes are stored. It's a big cabinet where you may keep your clothing and other fashion items. It is a well-organized area in a room that resembles a systemized cabinet or series of cabinets for hanging clothing, storing shoes, make-up, bedding enhancements, and other fashion accessories.

In the context of fashion, a wardrobe is a collection of clothes, handbags, shoes, and accessories designed to meet all of one's fashion and style requirements. That is why wardrobe enhancement is so crucial today. Drawers, chests, towels, hangers, boxes, jackets,

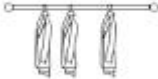
caps, and quilts are all represented by various symbols. Learn more details from this [wardrobe plan symbols²⁰](#) guide here.

Cabinet Dimension	Chest	Horizontal Board
		
Vertical Board	Clapboard with Size	Horizontal Clapboard
		
Vertical Clapboard	Top Box	Top Box (Right)
		
Drawer 1	Drawer 2	Drawer 3
		
Drawer 4	Drawer 5	Drawer 6
		
Drawer 7	Basket	Suitcase
		
Suitcase 2	Lattice	Clothes Hanger

²⁰ Wardrobe plan symbols: <https://www.edrawsoft.com/wardrobe-plan-symbols.html>

		
Trousers Hanger	Suitcase 3	Box
		
Towel	Towel 2	Pillow
		
Quilt 1	Quilt 2	Quilt 3
		
Hat	Hanger	Photo Frame
		
Clothes	Pants	Hooks
		
Closet Framework	Horizontal Clapboard 2	Vertical Clapboard 2
		
Clothes Hanger	Drawer 4	Drawer 5

		
Suitcase 2	Hanger 2	Towel 3
		
Towel 4	Towel 5	Quilt 2
		
Pillow 2	Hat 2	Blue Dress
		
Red Dress	T-Shirt	Shirt
		
Toy	Photo Frame 2	Cabinet Light
		
Droplight	Ceiling Light	Desk Lamp
		

Source: EdrawMax

3. Where to Find Floor Plan Symbols

It would help if you had proper **floor plan symbols** to create an accurate floor plan with details and a clear representation of each component. You can easily find floor plan symbols in the symbol library of EdrawMax.

You can easily find floor plan symbols in the symbol library of [EdrawMax²¹](#). EdrawMax gives you more than 26000 symbols that you can use to create a floor plan or any other diagram. You can go and search for the symbols you want in EdrawMax and click on the floor plan. Go to the floor plan category and use a simple drag and drop to add any symbol you want.

EdrawMax Floor Plan Symbols:

EdrawMax is the best resources for floor plan symbols, you can find hundreds of floor plan symbols here. Just drag and drop, you can create floor plan easily.

4. How to Use Floor Plan Symbols

Follow these instructions to learn how to use floor plan symbols and easily create more floor plan symbols with EdrawMax.

4.1 How to Use Floor Plan Symbols in EdrawMax

Instead of wasting time drawing the floor plan symbols or icons on paper, you should look for a way to design a floor plan easily. [EdrawMax](#) is well equipped to design a floor plan.

Step 1: Login EdrawMax

If you are new here, you should use your Email to register EdrawMax, but if you're already the EdrawMax's user, you just need to login EdrawMax for free. Open EdrawMax select "**Engineering**", and find "**Building Plan**", and click "**Floor Plan**", then open a new canvas or just open a built-in template.

²¹ EdrawMax: <https://www.edrawsoft.com/edraw-max/>

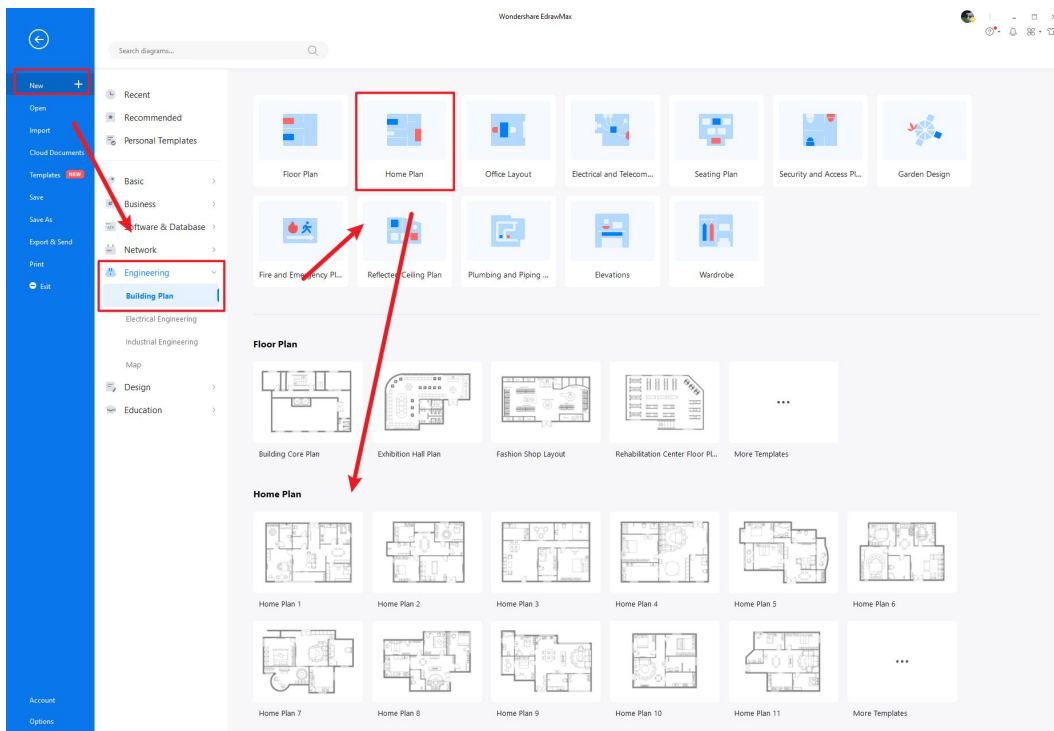

Step 2: Select Office Layout Symbols

Unlike physical drawing, EdrawMax helps to create a floor plan easily. In the symbol section of EdrawMax, you will find over 260,000 vector-based symbols that you can use in your designs. In EdrawMax, you can find floor plan symbols in **Symbol Libraries** on the left toolbar. You can click on the "+" option to open a new canvas to make your floor plan. On the left side of the canvas, you will see a symbol library with many floor plan symbols. You can search for specific symbols in the search bar.

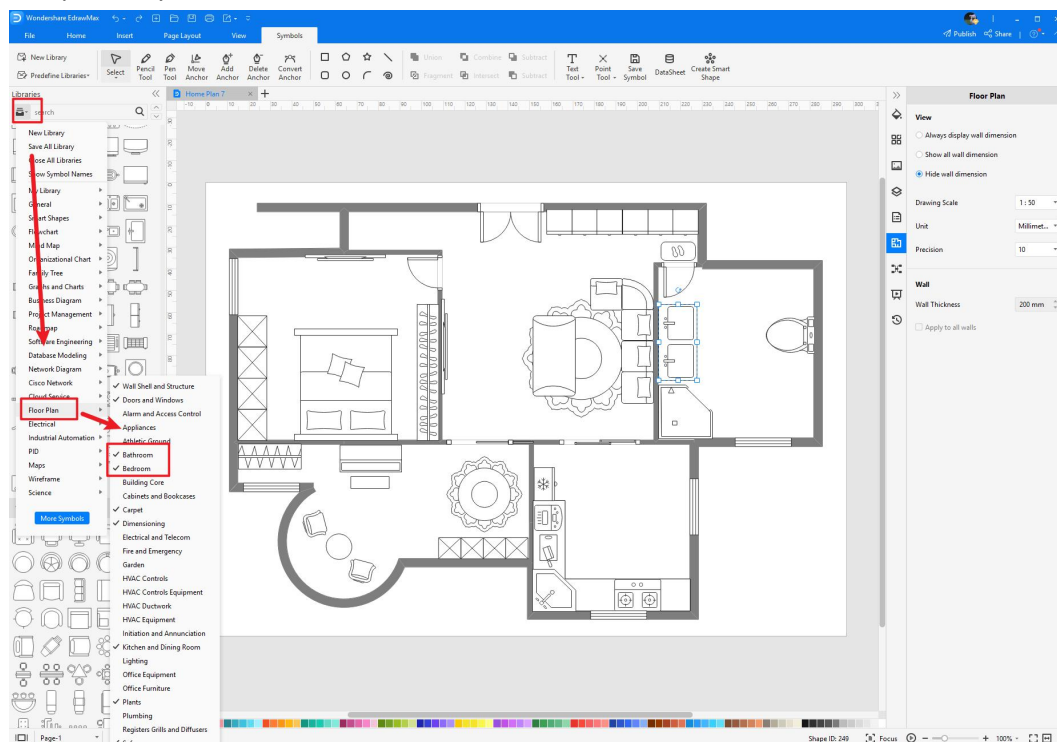

Step 3: Drag and Drop

Once you find the proper floor plan symbols you want, just drag and drop the symbols to the canvas easily. Keep customizing by choosing the right symbols, proper scale or dimensions, and adding more details, like color, font, and etc. When completed your floor plan, you can export your file or share your design effortlessly. Learn more [floor plan guide](#)²² here if necessary.

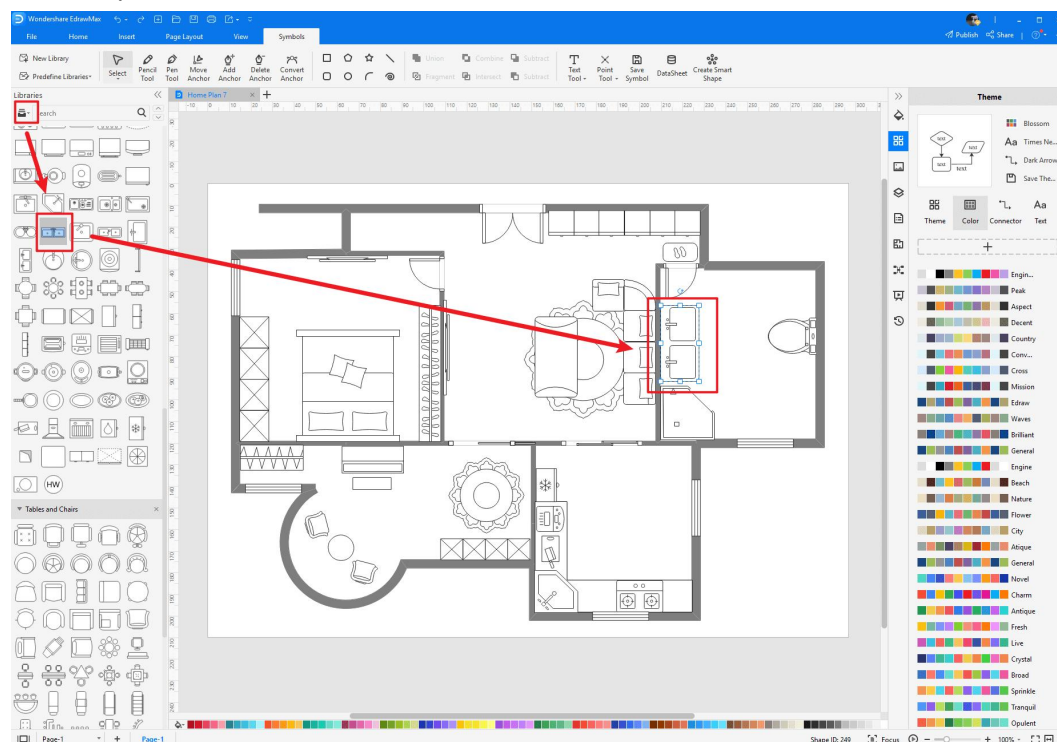

4.2 How to Create More Floor Plan Symbols in EdrawMax

EdrawMax provides you with thousands of symbols to create your diagram. Sometimes you want to use unique or personalized symbols in your diagram that are not in the library. EdrawMax gives you a simple solution to this problem. Follow these steps when you don't find the floor plan symbols you want or you wish to create your symbols to make your diagram.

Step 1: Find Symbol Tool

If you can't find any symbol similar to the one you want, you can use the pencil tool, pen tool, and anchor tool to draw your personalized floor plan symbols. It is much easier to draw the symbol you want on EdrawMax instead of searching for the one that suits your requirements. You can also save your symbol in the library for later use.

- Select "**Symbols**" on the upper Toolbar;

²² Floor plan guide: <https://www.edrawsoft.com/design-your-floorplans.html>

- Use "Pencil Tool", "Pen Tool", "Anchor Tool" to create garden symbol from very beginning;
- Choose "Union", "Combine", "Subtract", "Fragment", "Intersect", "Smart Shape" to make your symbols.

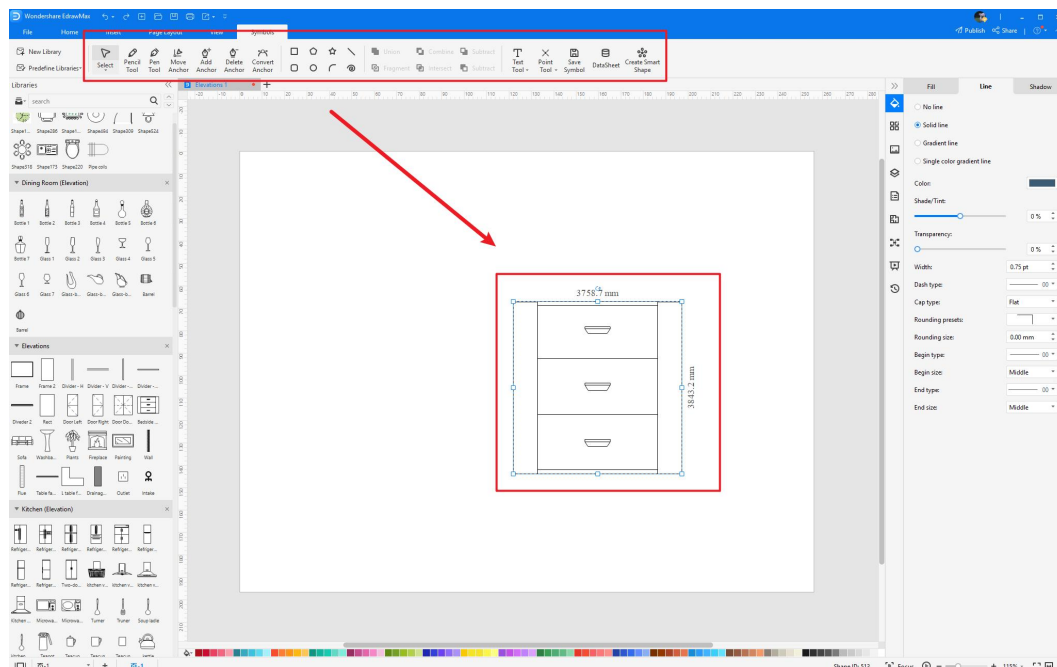

Step2: Create Floor Plan Symbols

When you create a floor plan, make sure that the size, design, and other attributes of your icon go along with other floor plan symbols. Follow these steps to draw perfect floor plan symbols.

- Draw a rectangle.
- Using the ruler to draw a diagonal line moving inwards to the door.
- Start from corner on the right side of the frame.
- Add more details to make it more like a door icon.

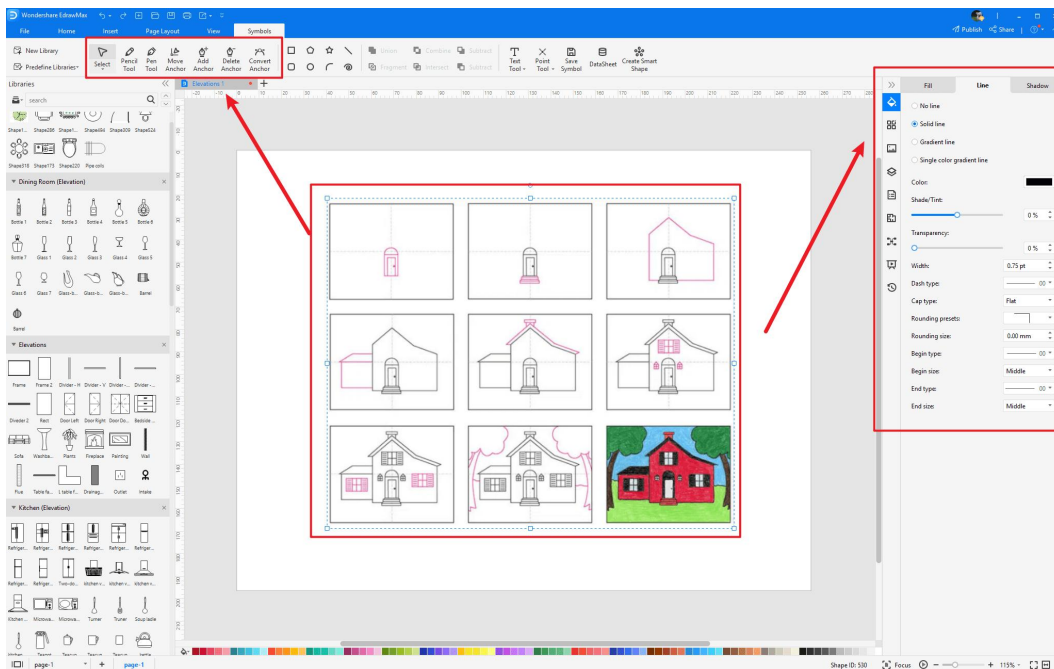

Step3: Import Floor Plan Symbols

Except for creating new floor plan symbols in EdrawMax, you can import floor plan symbols from your end. Find "Insert" on the top navigate toolbar, and import images to turn into symbols. Or click the third option of the right toolbar to insert images faster.

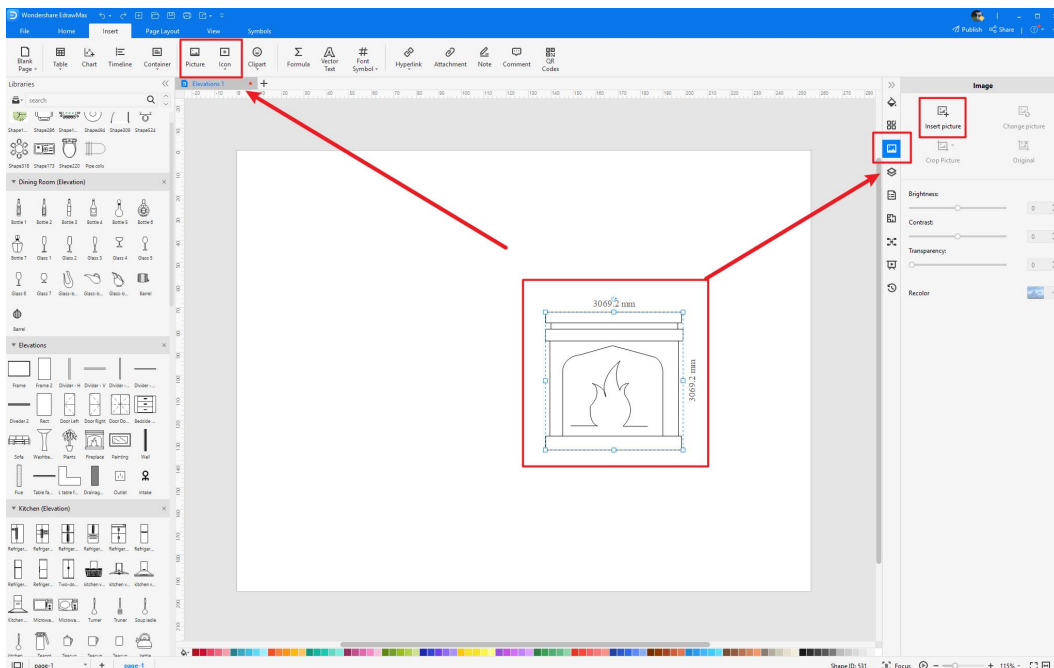

Step4: Save to Your Symbol Libraries

Once you completed your floor plan symbols design or import your symbol images, you should still click "Symbols" on top, and choose "Save Symbol" to your symbol Libraries. Or you can click "+" in My Library on the left toolbar. Learn more about how to draw a floor plan

or design a floor plan from this [floor plan guide](#) here.

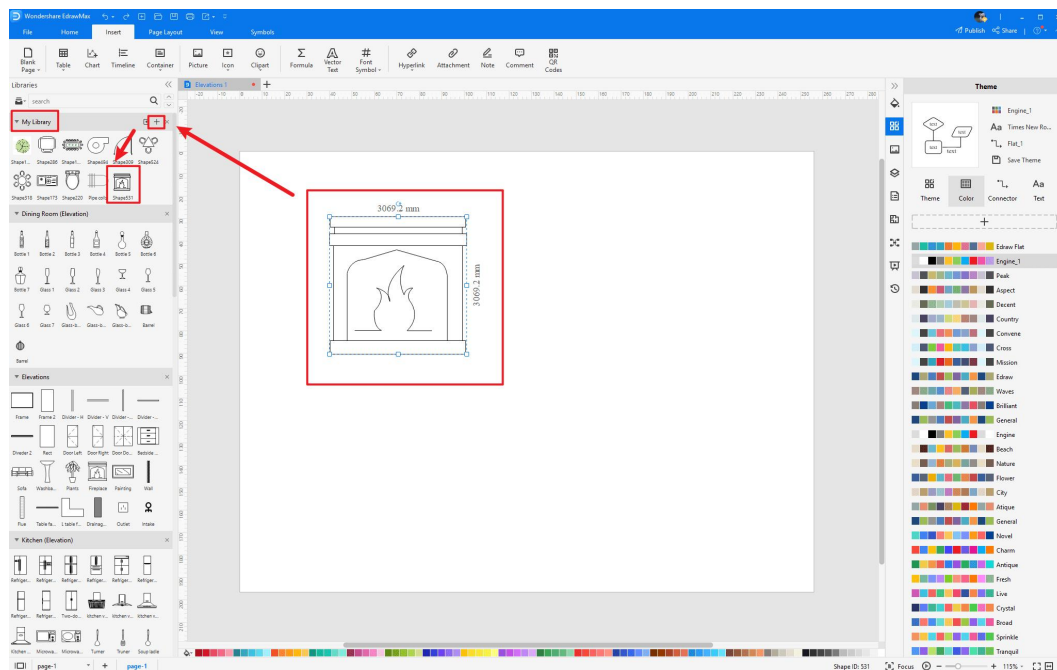

5. Free Floor Plan Creator

Creating a floor plan is much easier with free floor plan software, such as EdrawMax, instead of drawing it from scratch. With EdrawMax, you get a comprehensive symbol library with thousands of **floor plan** symbols that you can use to make your diagram. It also gives you free editable templates that you can customize in a few minutes and complete your diagram. EdrawMax is an excellent tool for team collaboration, and its easy-to-use interface makes it the first choice for everyone. These features make EdrawMax the best **free floor plan creator**²³.

key Features of EdrawMax:

- EdrawMax comes with free **floor plan examples & templates**²⁴ that are 100 percent customizable;
- The built-in vector symbols let you easily add floor plan components to your design;
- You can easily share the floor plans with your team and see the live revisions made by your team;
- EdrawMax lets you export the file in multiple formats, including MS Docs, PPTX, JPEG, PNG, PDF, and more;
- EdrawMax has a strong community of 25 million users who update the template community with their creative projects;
- EdrawMax is considered the best tool for beginners and professionals because of the user-friendly dashboard and easy drag-and-drop feature.

²³ Free floor plan creator: <https://www.edrawsoft.com/floor-plan-maker/>

²⁴ Floor plan examples & templates: <https://www.edrawsoft.com/free-floorplan-templates.html>

<p>EdrawMax Desktop</p> <p>Windows OS Linux</p> <ul style="list-style-type: none"> ✓ Create over 280 types of diagrams ✓ Windows, Mac, Linux (runs in all environments) ✓ Professional inbuilt resources and templates ✓ On-premises software for business ✓ Enterprise-level data security <p>DOWNLOAD</p>	<p>EdrawMax Online</p> <p>Cloud Sync Share</p> <ul style="list-style-type: none"> ✓ Create over 280 types of diagrams online ✓ Access diagrams anywhere, anytime ✓ Templates Community ✓ Team management and collaboration ✓ Personal Cloud and Dropbox Integration <p>TRY ONLINE</p>
---	---

6. Final Thoughts

An engineer or an architect designs a Floor Plan to have a detailed and elaborated view of a room or sections of a building from above. In this process, a floor plan is prepared using **floor plan symbols** which cover all the elements and equipment used and arranged in a building. It enables a Property owner to explain all the details, budget, scale, and placements for construction. A floor plan makes it easy for the designer to understand if the place is suitable for work or not.

EdrawMax is the best floor plan software with free templates and a large collection of symbols and icons. Professionals and beginners prefer EdrawMax because of its simple interface and fast diagramming tools. You can also import symbols from the web and download or share your diagram in any format you want using EdrawMax.

You May Also Like:

- ²⁵Building Plan Symbols:
- ²⁶Wardrobe Floor Plan Symbols:
- ²⁷Table & Chair Symbols:
- ²⁸Elevation Symbols:
- ²⁹Reflected Ceiling Plan Symbol

²⁵ Building Plan Symbols: <https://www.edrawsoft.com/building-core.html>

²⁶ Wardrobe Floor Plan Symbols: <https://www.edrawsoft.com/wardrobe-plan-symbols.html>

²⁷ Table & Chair Symbols: <https://www.edrawsoft.com/table-chairs.html>

²⁸ Elevation Symbols: <https://www.edrawsoft.com/elevations-symbols.html>

²⁹ Reflected Ceiling Plan Symbol: <https://www.edrawsoft.com/reflectedceiling-plan-symbols.html>



Wondershare EdrawMax

Visualize, Innovate, And Collaborate With
EdrawMax



www.edrawsoft.com



support@edrawsoft.com



www.facebook.com/edrawsoft



www.linkedin.com/company/edrawsoft



www.twitter.com/edrawsoft



www.youtube.com/c/cutedrawedwin/videos



www.pinterest.com/edrawsoft/_created



www.instagram.com/wondershare_edrawsoft
